

**ABBATTITORI SURGELATORI DI TEMPERATURA
CELLULES MIXTES DE REFROIDISSEMENT RAPIDE
SCHNELLKÜHLER/SCHOCKFROSTER
BLAST CHILLERS-FREEZERS
ABATIDORES-CONGELADORES RÁPIDOS DE TEMPERATURA
AFKOEL-VRIESKAST
ABATEDORES-CONGELADORES RÁPIDOS DA TEMPERATURA
БЫСТРЫЕ ОХЛАДИТЕЛИ-МОРОЗИЛЬНИКИ**

**MANUALE D'USO E INSTALLAZIONE
MANUEL D'UTILISATION ET D'INSTALLATION
BEDIEN- UND INSTALLATIONSHANDBUCH
USE AND INSTALLATION MANUAL
MANUAL DE USO E INSTALACIÓN
GEBRUIKS- EN INSTALLATIEHANDLEIDING
MANUAL DE USO E INSTALAÇÃO
РУКОВОДСТВО ПО ЭКСПЛУАТАЦИИ И УСТАНОВКЕ**



IT

Leggere attentamente le avvertenze contenute nel presente libretto in quanto forniscono importanti indicazioni riguardanti la sicurezza, d'uso e di manutenzione.

Conservare con cura questo libretto per ogni ulteriore consultazione dei vari operatori.

Il costruttore si riserva il diritto di apportare modifiche al presente manuale, senza preavviso e responsabilità alcuna.

FR

Lire avec attention les instructions contenues dans ce livret car elles fournissent d'importants renseignements pour ce qui concerne la sécurité, l'emploi et l'entretien.

Garder avec soin ce livret pour des consultations ultérieures de différents opérateurs.

Le constructeur se réserve le droit d'apporter des modifications à ce manuel, sans préavis ni responsabilité d'aucune sorte.

DE

Lesen Sie bitte aufmerksam diese Gebrauchsanweisung durch, die wichtige Informationen bezüglich der Sicherheit, dem Gebrauch und der Instandhaltung enthält.

Heben Sie sorgfältig diese Gebrauchsanweisung auf, damit verschiedene Anwender sie zu Rat ziehen können.

Der Hersteller behält sich das Recht, Änderungen dieser Gebrauchsanweisung ohne Ankündigung und ohne Übernahme der Verantwortung vornehmen zu können.

GB

Carefully read the instructions contained in the handbook. You may find important safety instructions and recommendations for use and maintenance.

Please retain the handbook for future reference.

The Manufacturer is not liable for any changes to this handbook, which may be altered without prior notice.

ES

Lea atentamente las advertencias contenidas en este manual pues dan importantes indicaciones concernientes la seguridad, la utilización y el mantenimiento del aparato.

Rogamos guarde el folleto de instalación y utilización, para eventuales futuros usuarios.

El constructor se reserva el derecho de hacer modificaciones al actual manual, sin dar algún preaviso y sin responsabilidad alguna.

NL

Nauwkeurig de waarschuwingen in dit boekje lezen, aangezien zij belangrijke aanwijzingen verschaffen wat betreft de veiligheid, het gebruik en het onderhoud.

Dit boekje goed bewaren.

De fabrikant behoudt zich het recht voor om veranderingen in deze handleiding aan te brengen, zonder voorafgaande waarschuwing en zonder enkele aansprakelijkheid.

P

Leia com atenção as advertências contidas neste manual pois fornecem importantes indicações para a segurança, a utilização e a manutenção do aparelho.

O construtor reserva-se o direito de modificar o manual sem dar aviso prévio e sem nenhuma responsabilidade.

RU

Внимательно читайте предупреждения, содержащиеся в настоящем руководстве, касающиеся надежности использования и обслуживания.

Конструктор сохраняет за собой право вносить изменения в настоящее руководство без предупреждения и любой ответственности.

- INDEX -

1 st PART		INSTRUCTION MANUAL	3
----------------------	---	--------------------------	---

2 st PART		INSTALLATION MANUAL	21
----------------------	---	---------------------------	----

0	INFORMATION FOR THE READER	3
1	GENERAL INSTRUCTIONS ON DELIVERY	3
	• GENERAL INSTRUCTIONS	3
	• TECHNICAL DATA	3
	• LIST OF REGULATION REFERENCES	3
	• GENERAL INSTRUCTIONS	3
	• SETTING UP	4
	• TESTING	4
	MACHINE LOADING	5
	POSITION OF TRAYS	5
	LENGTH	5
2	CONTROL PANEL	7
	• DESCRIPTION OF CONTROLS	7
	• CORE PROBE	8
	• GENERAL SETTING	9
	TEMPERATURE UNIT OF MEASUREMENT	9
3	WORKING	10
	• QUICK COOLING CYCLE	10
	CORE PROBE POSITIVE SOFT QUICK COOLING CYCLE	11
	CORE PROBE POSITIVE HARD QUICK COOLING CYCLE	11
	CORE PROBE NEGATIVE QUICK COOLING CYCLE	12
	TIME-CONTROLLED POSITIVE SOFT QUICK COOLING CYCLE	13
	TIME-CONTROLLED POSITIVE HARD QUICK COOLING CYCLE	13
	TIME-CONTROLLED NEGATIVE QUICK COOLING CYCLE	14
	• USE OF STANDARD PROGRAMMES	15
	CORE PROBE POSITIVE SOFT QUICK COOLING CYCLE	15
	CORE PROBE POSITIVE HARD QUICK COOLING CYCLE	15
	CORE PROBE NEGATIVE QUICK COOLING CYCLE	15
	TIME-CONTROLLED POSITIVE SOFT QUICK COOLING CYCLE	15
	TIME-CONTROLLED POSITIVE HARD QUICK COOLING CYCLE	16
	TIME-CONTROLLED NEGATIVE QUICK COOLING CYCLE	16
	• DEFROSTING	16
4	MAINTENANCE	17
	• MAINTENANCE AND CLEANING	17
	CLEANING THE CABINET	17
	CLEANING THE AIR CONDENSER	18
	STAINLESS-STEEL MAINTENANCE	18
	DISCONTINUED USE	19



- INDEX -



• INSTALLATION	21
INTRODUCTION	21
MAX ROOM TEMPERATURE	21
POSITIONING	21
WIRING	23
PLEASE USE CERTIFIED APPROVED MATERIALS	23
• GENERAL SETTING	24
TESTING	24
• SERVICE FUNCTIONS	24
CHANGING PARAMETERS	24
DESCRIPTION OF PARAMETERS	25
• ALARMS AND FAULT ANALYSIS	27
• MAINTENANCE OF PANEL BOARD	28
• WIRING DIAGRAM PLATE	29
• CONTROL AND SAFETY SYSTEMS	29
• DISPOSAL	29
• REFRIGERANT MATERIAL SAFETY DATA SHEET	29
• DIMENSIONS	31
ANNEXES	33

- INSTRUCTION MANUAL -

INFORMATION FOR THE READER

CHAPTER 0

This manual is subdivided into two parts.



1st part: covers all the information necessary to the user.



2nd part: covers all the information necessary to the qualified operators authorized to move, transport, install, service, repair and demolish the appliance.

While users are instructed to refer to the 1st part only, the 2nd part is addressed to skilled operators. They may also read the 1st part for a more complete picture of the information provided if necessary.

GENERAL INSTRUCTIONS ON DELIVERY

CHAPTER 1

GENERAL INSTRUCTIONS

Make sure that the consignment has not been tampered with or damaged during transport.

After unpacking the cooling cabinet make sure all sections or components have been included and specifications and conditions are as to your order. If not, please inform the retailer immediately.

We assure you have made the best choice in purchasing our products and hope you will be fully satisfied with our their performance. To this purpose, we recommend you strictly comply with the instructions and regulations contained in this handbook.

Please remember that no reproductions of this handbook are allowed. Due to our constant technological updating and research, the features described in this handbook may be altered without prior notice.



TECHNICAL DATA

Please refer to the technical data of your own appliance. (tab.1)

LIST OF REGULATION REFERENCES

The cooling cabinet we manufacture fully complies with the following European and national regulations:

89/392;91/368;93/44 (machine regulations)
89/336 (EMC regulation)
73/23 (low-voltage regulation)
93/68 (new approach regulation)
658/88 CEE
108/89 CEE
DPR 327/80 art.31 (Italy)
D.M. 15-06-71 (Italy)
D.L. n°110 27-01-92 (Italy)

J.O. 16-07-74 n°74-163 (France) and the following European regulations:
EN60204-1;EN292-I-II;EN294;EN349
EN55014;EN55104
EN60335-1;EN60335-2-24
EN378-1
NF D 40-001 (France)
NF E 35-400 (France)
U 60-010 (France)

GENERAL INSTRUCTIONS

The quick cooler is a refrigerating appliance which can cool cooked foodstuffs to a temperature of +3°C (positive quick cooling) and to -18°C (negative quick cooling).

Machine capacity as to the quantity to be cooled depend on the model purchased.

- INSTRUCTION MANUAL -

SETTING UP

Before setting to operation thoroughly clean the cooling cabinet with a suitable detergent or sodium bycarb dissolved in lukewarm water. Clean the appliance inside to remove any condensate caused by the Manufacturer's final testing.

Cooling and freezing speed depends on the following factors:

- a) container shape, type and material;
- b) whether container lids are used;
- c) foodstuff features (density, water contents, fat contents);
- d) starting temperature;
- e) thermal conduction inside the foodstuffs

Positive /Negative quick cooling time depends on type of foodstuffs to be processed.

Full-speed cycle is recommended for high-density or large-sized foodstuffs. However, the following limits should never be exceeded : 3,6 [kg] load (for GN1/1, EN1/1 or 60x40 sheets) or 7,2 [kg] load (for GN2/1, EN2/1 or 60x80 sheets), 50 [mm] thickness for negative quick cooling and 80 [mm] thickness for positive quick cooling (**tab.2**).

The low-speed cycle is suitable to process delicate foodstuffs, such as vegetables, creamy products, creamy desserts or low-thickness products.

We recommend making sure that any positive quick cooling cycles, up to +3 [°C] to the core of the product, do not last over 90 minutes, and that negative quick cooling cycles, up to -18 [°C] to the core of the product, do not last over 4 hours.

The processing room is to be pre-cooled before starting the positive and /or negative quick cooling cycle. Moreover, avoid covering the foodstuffs during the cycle, which would increase the cycle length.

We recommend using the core probe in order to have the exact core temperature reading. Do not stop the cycle before reaching a temperature of +3 [°C] during positive quick cooling and -18[°C] during negative quick cooling.



Tab.2

Model	Max. output/cycle		Capacity		
	+70[°C]÷+3[°C]	+70[°C]÷-18[°C]	n° max	GN	EN
DM31-DM31A-DM31M-DM31C	10,8[kg]	3,6[kg]	5	1/1	600x400
DS31-DS31A-DS31M-DS31C					
DS351H					
DM51-DM51A-DM51M-DM51C	20[kg]	12[kg]	5	1/1	600x400
DMS51-DMS51A-DMS51M-DMS51C					
DS51-DS51A-DS51M-DS51C					
DM51ME	14,4[kg]	7,2[kg]	5	1/1	600x400
DM101L	42[kg]	25[kg]	10	1/1	600x400
DMS101L - DMS101LR					
DMS101S- DMS101SR					
DM72S	52[kg]	25[kg]	10	2/1	600x800
DMS72S - DMS72SR					
DM102S	100[kg]	50[kg]	10	2/1	600x800
DMS102S - DMS102SR					

Model	Max. output/cycle	n° max	Capacity	
	-10[°C] ÷25[°C]		n° max	cm
DMG51C - DMG51M - DSG51M	12[kg]	6	36x16,5x12	
DMG51ME - DSG51ME	7[kg]	6	36x16,5x12	
DMG101L	25[kg]	12	36x16,5x12	

TESTING

Name and Surname	Address	Tel./fax no.

- INSTRUCTION MANUAL -

MACHINE LOADING

Do not pile up foodstuffs to be cooled. Thickness should be lower than 50 mm] in negative quick cooling and lower than 80[mm] in positive quick cooling. **(pict.1)**

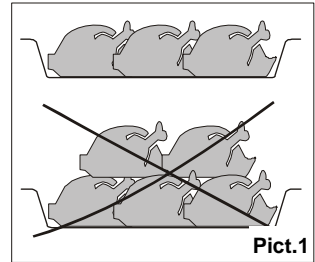

Pict.1

Make sure air circulation is not hampered between food trays. **(pict.2)**

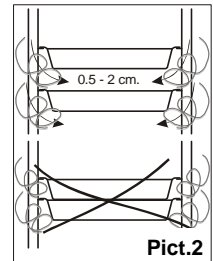

Pict.2

The grid-holding frame (included in those models which include trolleys) is to be located at the centre of the cabinet. **(pict.3)**

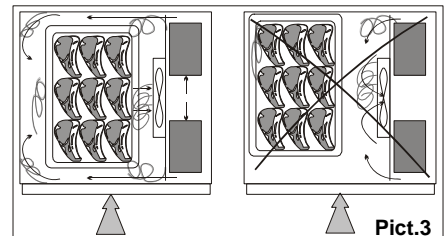

Pict.3

POSITION OF TRAYS

Place the trays as close to the evaporator as possible. **(pict.4)**

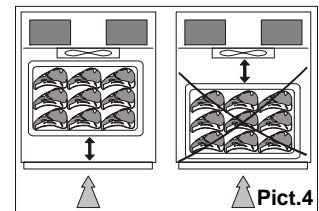

Pict.4

If the cabinet is not full place the trays at equal distance from one another. **(pict.5)**

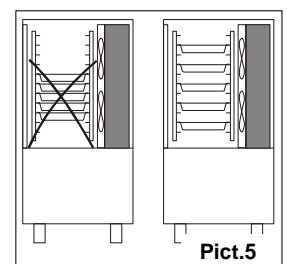

Pict.5

LENGTH

Cooled or frozen processed foodstuffs may be stored in a refrigerator for 5 days of processing with no quality alterations.

For best results we recommend keeping temperature constant throughout the storing (0°C to 4°C), according to the various commodities.

Storing time may be increased to approx. two weeks by using vacuum processing.

After a negative quick cooling cycle, foodstuffs may be stored safely for 3 to 18 months, according to the type of foodstuff processed.

We strongly recommend keeping storing temperature at -20°C or below.

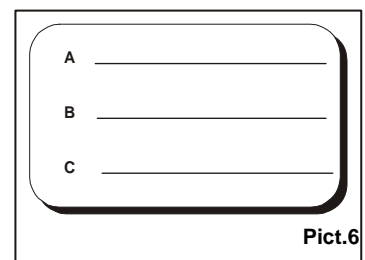

Pict.6



- INSTRUCTION MANUAL -

Table 3 shows the storing time rates for a few examples of frozen food.

Do not leave cooked products at room temperature before quick cooling.

Avoid any loss of moisture, which will affect food freshness.

The cooled product should be wrapped in a specific film for foodstuffs (better still, vacuum stored) and provided with a sticker reporting the content [A], date of processing [B] and expiry date [C] written in permanent type ink (**pict.6**).

Tab.3

Foodstuff	Storing temperature [°C]	Recommended storing time
Pork	-18	6
Beef	-18	9
Poultry	-18	10
Fat fish	-18	2
Lean fish	-18	4
Peas	-18	12
Strawberries	-18	12
Spinach	-18	6



- INSTRUCTION MANUAL -

CONTROL PANEL

CHAPTER 2









DESCRIPTION OF CONTROLS



	<p><u>TIME-CONTROLLED POSITIVE QUICK COOLING KEY</u> <i>With the card on standby:</i></p> <ul style="list-style-type: none"> • press this key once to select a time-controlled positive SOFT QC cycle • by pressing again , a time-controlled positive HARD QC cycle can be selected
	<p><u>DEFROST KEY</u> <i>With the card on standby:</i></p> <ul style="list-style-type: none"> • press this key once to start a defrost cycle
	<p><u>STANDBY KEY</u> <i>With the card Off:</i></p> <ul style="list-style-type: none"> • press this key once to set the card to the standby mode <p><i>With the card on standby and the cycle selected:</i></p> <ul style="list-style-type: none"> • press this key once to start the cycle <p><i>With the card set on cycle running:</i></p> <ul style="list-style-type: none"> • press this key once to stop the cycle <p>NOTE: <i>If you hold this key pressed for 3 seconds, you can set the card to Off from any mode.</i></p>
	<p><u>TIME-CONTROLLED NEGATIVE QUICK COOLING KEY</u> <i>With the card on the standby:</i></p> <ul style="list-style-type: none"> • press this key once to select a time-controlled positive QUICK COOLING cycle
	<p><u>CORE PROBE POSITIVE QUICK COOLING KEY</u> <i>With the card on standby:</i></p> <ul style="list-style-type: none"> • press this key once to select a core probe positive SOFT QC • by pressing again, a core-probe positive HARD QC cycle can be selected
	<p><u>UP AND DOWN KEYS</u> Use these keys to increase or decrease values</p>
	<p><u>CORE PROBE NEGATIVE QUICK COOLING KEY</u> <i>With the card on standby:</i></p> <ul style="list-style-type: none"> • press this key once to select a core probe negative QC



- INSTRUCTION MANUAL -

	<u>NEGATIVE QUICK COOLING ICON</u> It blinks during negative QC, stays on during the following storing phase
	<u>POSITIVE QUICK COOLING ICON</u> It blinks during positive QC, stays on during the following storing phase
	<u>STORING ICON</u> It is on or blinks during a storing cycle
	<u>CORE PROBE ICON</u> It is on during a core probe cycle
	<u>TIME ICON</u> It is on during a time-controlled cycle
	<u>OFF ICON</u> It is on when the card is set to off; it is off in any other state of the card
	<u>FAHRENHEIT ICON</u> The red or green icon, depending on the colour of the display, is on if any temperature is displayed in degrees Fahrenheit
	<u>CELSIUS ICON</u> The red or green icon, depending on the colour of the display, is on if any temperature is displayed in degrees Celsius

CORE PROBE



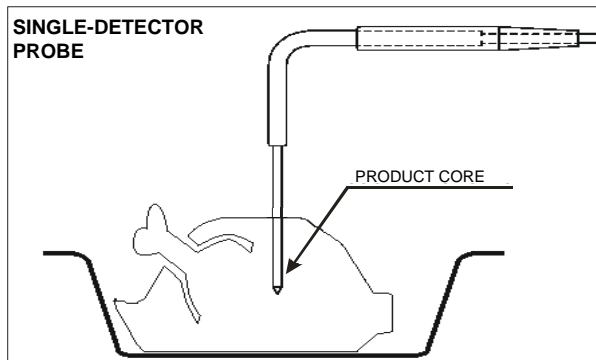



For correct probe installation, refer to the following illustration.



- INSTRUCTION MANUAL -

GENERAL SETTING

TEMPERATURE UNIT OF MEASUREMENT

	With the card <i>Off</i> , press the <u>defrost</u> and <u>standby</u> keys for 3 seconds to gain access to the mode for programming parameters The <u>display</u> shows "PASS"
	Use the <u>up</u> and <u>down</u> keys to scroll all the user parameters and display " P0 "
	Press the <u>core probe negative QC</u> key to confirm your selection
	Use the <u>up</u> and <u>down</u> keys to select the new parameter value (0 Fahrenheit, 1 Celsius)
	Press the <u>core probe negative QC</u> key to confirm your selection
	Press the <u>standby</u> key to exit



- INSTRUCTION MANUAL -

OPERATION

CHAPTER 3

QUICK COOLING CYCLE

- **CORE PROBE POSITIVE SOFT QUICK COOLING CYCLE** : cycle suitable for cooling foodstuffs with thickness lower than 4[cm] using a room temperature of about 0[°C]. The cycle is controlled by the core probe.
- **CORE PROBE POSITIVE HARD QUICK COOLING CYCLE** : cycle suitable for cooling foodstuffs with thickness exceeding 4[cm] using a room temperature ranging from -30[°C] to -5[°C]. The cycle is controlled by the core probe.
- **CORE PROBE NEGATIVE QUICK COOLING CYCLE**: cycle suitable for freezing foodstuffs using a room temperature of about -30[°C]. The cycle is controlled by the core probe.
- **TIME-CONTROLLED POSITIVE SOFT QUICK COOLING CYCLE**: cycle suitable for cooling foodstuffs with thickness lower than 4[cm] using a room temperature of about 0[°C]. The cycle is time-controlled.
- **TIME-CONTROLLED POSITIVE HARD QUICK COOLING CYCLE** : cycle suitable for cooling foodstuffs with thickness exceeding 4[cm] using a room temperature ranging from -30[°C] to -5[°C]. The cycle is time-controlled.
- **TIME-CONTROLLED NEGATIVE QUICK COOLING CYCLE** : cycle suitable for freezing foodstuffs using a room temperature of about -30[°C]. The cycle is time-controlled.

NOTE: At the end of the quick cooling phase, the device starts the storing phase (+2[°C] at the end of the positive quick cooling; -22[°C] at the end of the negative quick cooling).









Cooling time

FOODSTUFF	SHEET	MAX. LOAD	PRODUCT THICKNESS	QUICK COOLING TIME	ROOM TEMPERATURE	CORE TEMPERATURE
FIRST COURSES						
Bechamel	GN1/1 h60	6 lt	4 cm	70 minutes	-20 °C	3°C
Meat broth	GN1/1 h110	8 lt	6-7 cm	110 minutes	-20 °C	3°C
Cannelloni	GN1/1 h40	4 Kg	3-4 cm	40 minutes	-20 °C	3°C
Vegetable soup	GN1/1 h100	5 lt	5 cm	100 minutes	-20 °C	3°C
Fresh pasta	GN1/1 h40	1 Kg	5 cm	20 minutes	-20 °C	3°C
Meat and tomato sauce	GN1/1 h60	5 Kg	5 cm	90 minutes	-20 °C	3°C
Bean soup	GN1/1 h60	5 Kg	5 cm	100 minutes	-20 °C	3°C
Fish soup	GN1/1 h60	4 Kg	5 cm	110 minutes	-20 °C	3°C
MEAT AND POULTRY						
Roast pork	GN1/1 h60	8 Kg	10 cm	110 minutes	-20 °C	3°C
Braised beef	GN1/1 h60	8 Kg	15 cm	110 minutes	-20 °C	3°C
Boiler beef	GN1/1 h60	6 Kg	12-18 cm	110 minutes	-20 °C	3°C
Chicken breast	GN1/1 h40	5 Kg	4-5 cm	30 minutes	0 °C	3°C
Roast-beef	GN1/1 h40	4 Kg	10-15 cm	80 minutes	-20 °C	3°C
FISH						
Baked grouper	GN1/1 h40	3 Kg	5-10 cm	110 minutes	-20 °C	3°C
Squill	GN1/1 h40	2 Kg	3 cm	25 minutes	-20 °C	3°C
Vacuum-stored mussel	grid GN1/1	2 Kg	max 3-4 cm	20 minutes	-20 °C	3°C
Fish salad	GN1/1 h40	4 Kg	3-4 cm	30 minutes	0 °C	3°C
Boiled polyp	GN1/1 h60	5 Kg	-	60 minutes	-20 °C	3°C
Stewed cuttlefish	GN1/1 h60	4 Kg	4-5 cm	60 minutes	-20 °C	3°C
VEGETABLES						
Carrots trifolate	GN1/1 h60	4 Kg	4-5 cm	60 minutes	-20 °C	3°C
Mushrooms trifolati	GN1/1 h60	4 Kg	4-5 cm	60 minutes	-20 °C	3°C
Zucchini trifolate	GN1/1 h60	3 Kg	4-5 cm	90 minutes	-20 °C	3°C
PASTRY/DESSERT						
Vanilla / chocolate pudding	GN1/1 h60	6 lt	4-5 cm	90 minutes	0 °C	3°C
Creme anglaise	GN1/1 h60	3 lt	4-5 cm	100 minutes	0 °C	3°C
Custard a	GN1/1 h60	3 lt	4-5 cm	100 minutes	0 °C	3°C
Panna cotta (single portion)	grid	3 lt	6 cm	60 minutes	0 °C	3°C
Ice-cream cake	grid	3 Kg	4-6 cm	50 minutes	0 °C	3°C
Tiramisù	GN1/1 h60	5 Kg	4-5 cm	45 minutes	0 °C	3°C







- INSTRUCTION MANUAL -

CORE PROBE POSITIVE SOFT QUICK COOLING CYCLE





	<p>Press the <u>core probe positive QC</u> key to select a core probe positive Soft QC The <u>display</u> shows SOFT for 3 seconds</p> <p>The core probe icon and <u>positive QC</u> icon start blinking The <u>display</u> shows the room probe temperature setpoint during QC</p>
	<p>Use the <u>up</u> and <u>down</u> keys to change the value</p>
	<p>Press the <u>core probe positive QC</u> key to confirm the value</p> <p>The <u>display</u> shows the product temperature setpoint The <u>positive QC</u> icon stays on The core probe icon keeps blinking</p>
	<p>Use the <u>up</u> and <u>down</u> keys to change the value</p>
	<p>Press the <u>core probe positive QC</u> key to confirm the value</p> <p>The <u>display</u> shows the room temperature during storing The <u>positive QC</u> icon stays on The <u>storing</u> icon and the core probe icon blink</p>
	<p>Use the <u>up</u> and <u>down</u> keys to change the value</p>
	<p>Press the <u>core probe positive QC</u> key to confirm the value</p>
	<p>Press the <u>standby</u> key to start the cycle</p>



CORE PROBE POSITIVE HARD QUICK COOLING CYCLE







	<p>Press the <u>core probe positive QC</u> key to select a core probe positive Soft QC The <u>display</u> shows SOFT for 3 seconds</p>
	<p>Press the <u>core probe positive QC</u> key to select a core probe positive Hard QC The <u>display</u> shows HARD</p> <p>The core probe icon and <u>positive QC</u> icon start blinking The <u>display</u> shows the room probe temperature setpoint during QC</p>
	<p>Use the <u>up</u> and <u>down</u> keys to change the value</p>
	<p>Press the <u>core probe positive QC</u> key to confirm the value</p> <p>The <u>display</u> shows the product temperature setpoint The <u>positive QC</u> icon stays on The core probe icon keeps blinking</p>

- INSTRUCTION MANUAL -

	<p>Use the <u>up</u> and <u>down</u> keys to change the value</p>
	<p>Press the <u>core probe positive QC</u> key to confirm the value</p> <p>The <u>display</u> shows the room temperature during storing The <u>positive QC</u> icon stays on The <u>storing</u> icon and the core probe icon blink</p>
	<p>Use the <u>up</u> and <u>down</u> keys to change the value</p>
	<p>Press the <u>core probe positive QC</u> key to confirm the value</p>
	<p>Press the <u>standby</u> key to start the cycle</p>









CORE PROBE NEGATIVE QUICK COOLING CYCLE



	<p>Press the <u>core probe negative QC</u> key to select the corresponding cycle</p> <p>The core probe icon and <u>negative QC</u> icon start blinking</p> <p>The <u>display</u> shows the room probe temperature setpoint during QC</p>
	<p>Use the <u>up</u> and <u>down</u> keys to change the value</p>
	<p>Press the <u>core probe negative QC</u> key to confirm the value</p> <p>The <u>display</u> shows the product temperature setpoint The <u>negative QC</u> icon lights on The core probe icon keeps blinking</p>
	<p>Use the <u>up</u> and <u>down</u> keys to change the value</p>
	<p>Press the core probe negative QC key to confirm the value</p> <p>The display shows the room temperature during storing The negative QC icon stays on The storing icon and the core probe icon blink</p>
	<p>Use the up and down keys to change the value</p>
	<p>Press the core probe negative QC key to confirm the value</p>
	<p>Press the standby key to start the cycle</p>





- INSTRUCTION MANUAL -

TIME-CONTROLLED POSITIVE SOFT QUICK COOLING CYCLE





	<p>Press the <u>time-controlled positive QC</u> key to to select a time-controlled positive Soft QC cycle The <u>display</u> shows SOFT for 3 seconds</p> <p>The <u>time</u> icon and <u>positive QC</u> icon blink The <u>display</u> shows the room probe temperature setpoint during QC</p>
	<p>Use the <u>up</u> and <u>down</u> keys to change the value</p>
	<p>Press the <u>time-controlled positive QC</u> key to confirm the value</p> <p>The <u>display</u> shows the cycle duration The <u>positive QC</u> icon stays on The <u>time</u> icon keeps blinking</p>
	<p>Use the <u>up</u> and <u>down</u> keys to change the value</p>
	<p>Press the <u>time-controlled positive QC</u> key to confirm the value</p> <p>The <u>display</u> shows the room temperature during storing The <u>positive QC</u> icon stays on L'icona <u>conservazione</u> e l'icona <u>tempo</u> lampeggiano</p>
	<p>Use the <u>up</u> and <u>down</u> keys to change the value</p>
	<p>Press the <u>time-controlled positive QC</u> key to confirm the value</p>
	<p>Press the <u>standby</u> key to start the cycle</p>











TIME-CONTROLLED POSITIVE HARD QUICK COOLING CYCLE

	<p>Press the <u>time-controlled positive QC</u> key to to select a time-controlled positive Soft QC cycle The <u>display</u> shows SOFT for 3 seconds</p>
	<p>Press the <u>time-controlled positive QC</u> key to to select a time-controlled positive Hard QC cycle The <u>display</u> shows HARD</p> <p>The <u>time</u> icon and <u>positive QC</u> icon blink The <u>display</u> shows the room probe temperature setpoint during QC</p>
	<p>Use the <u>up</u> and <u>down</u> keys to change the value</p>
	<p>Press the <u>time-controlled positive QC</u> key to confirm the value</p> <p>The <u>display</u> shows the cycle duration The <u>positive QC</u> icon stays on The <u>time</u> icon keeps blinking</p>

- INSTRUCTION MANUAL -

	Use the <u>up</u> and <u>down</u> keys to change the value
	Press the <u>time-controlled positive QC</u> key to confirm the value The <u>display</u> shows the room temperature during storing The <u>positive QC</u> icon stays on L'icona <u>conservazione</u> e l'icona <u>tempo</u> lampeggiano
	Use the <u>up</u> and <u>down</u> keys to change the value
	Press the <u>time-controlled positive QC</u> key to confirm the value
	Press the <u>standby</u> key to start the cycle

TIME-CONTROLLED NEGATIVE QUICK COOLING CYCLE

	Press the <u>time-controlled negative QC</u> key to select the corresponding cycle The <u>time</u> icon and <u>negative QC</u> icon blink The <u>display</u> shows the room probe temperature setpoint during QC
	Use the <u>up</u> and <u>down</u> keys to change the value
	Press the <u>time-controlled negative QC</u> key to confirm the value The <u>display</u> shows the cycle duration The <u>negative QC</u> icon lights on The <u>time</u> icon keeps blinking
	Use the <u>up</u> and <u>down</u> keys to change the value
	Press the <u>time-controlled negative QC</u> key to confirm the value The <u>display</u> shows the room temperature during storing The <u>negative QC</u> icon stays on The <u>storing</u> icon and the <u>time</u> icon blink
	Use the <u>up</u> and <u>down</u> keys to change the value
	Press the <u>time-controlled negative QC</u> key to confirm the value
	Press the <u>standby</u> key to start the cycle



- INSTRUCTION MANUAL -

USE OF STANDARD PROGRAMMES

The standard programmes are work cycles recommended by the manufacturer with pre-set parameters.

CORE PROBE POSITIVE SOFT QUICK COOLING CYCLE

	<p>Press the <u>core probe positive QC</u> key to select a core probe positive Soft QC The <u>display</u> shows SOFT for 3 seconds</p> <p>The core probe icon and <u>positive QC</u> icon start blinking The <u>display</u> shows the room probe temperature setpoint during QC</p>
	<p>Press the <u>standby</u> key to start the cycle</p>

CORE PROBE POSITIVE HARD QUICK COOLING CYCLE

	<p>Press the <u>core probe positive QC</u> key to select a core probe positive Soft QC The <u>display</u> shows SOFT for 3 seconds</p>
	<p>Press the <u>core probe positive QC</u> key to select a core probe positive Hard QC The <u>display</u> shows HARD</p> <p>The core probe icon and <u>positive QC</u> icon start blinking The <u>display</u> shows the room probe temperature setpoint during QC</p>
	<p>Press the <u>standby</u> key to start the cycle</p>



CORE PROBE NEGATIVE QUICK COOLING CYCLE

	<p>Press the <u>core probe negative QC</u> key to select the corresponding cycle</p> <p>The core probe icon and <u>negative QC</u> icon start blinking</p> <p>The <u>display</u> shows the room probe temperature setpoint during QC</p>
	<p>Press the <u>standby</u> key to start the cycle</p>

TIME-CONTROLLED POSITIVE SOFT QUICK COOLING CYCLE

	<p>Press the <u>time-controlled positive QC</u> key to select a time-controlled positive Soft QC cycle The <u>display</u> shows SOFT for 3 seconds</p> <p>The <u>time</u> icon and <u>positive QC</u> icon blink The <u>display</u> shows the room probe temperature setpoint during QC</p>
	<p>Press the <u>standby</u> key to start the cycle</p>

- INSTRUCTION MANUAL -

TIME-CONTROLLED POSITIVE HARD QUICK COOLING CYCLE

	Press the <u>time-controlled positive QC</u> key to to select a time-controlled positive Soft QC cycle The <u>display</u> shows SOFT for 3 seconds
	Press the <u>time-controlled positive QC</u> key to to select a time-controlled positive Hard QC cycle The <u>display</u> shows HARD
	The <u>time</u> icon and <u>positive QC</u> icon blink The <u>display</u> shows the room probe temperature setpoint during QC
	Press the <u>standby</u> key to start the cycle

TIME-CONTROLLED NEGATIVE QUICK COOLING CYCLE

	Press the <u>time-controlled negative QC</u> key to select the corresponding cycle
	The <u>time</u> icon and <u>negative QC</u> icon blink The <u>display</u> shows the room probe temperature setpoint during QC
	Press the <u>standby</u> key to start the cycle



DEFROSTING

	With the card on standby, press the <u>defrost</u> key to start the corresponding cycle During this cycle, the <u>display</u> shows "DEF", which starts blinking during the dripping phase
--	---

The defrost duration is regulated by the card.

Note: you can stop the defrost cycle at any time by pressing the key



- INSTRUCTION MANUAL -

MAINTENANCE

CHAPTER 4

MAINTENANCE AND CLEANING

CLEANING THE CABINET

Clean inside the cooling cabinet daily.

Both the cabinet and all the internal components have been designed and shaped to allow washing and cleaning all parts easily.

Before cleaning, defrost the appliance and remove the internal drain.

Disconnect the master switch.

Clean all components (stainless-steel, plastic or painted parts) with lukewarm water and detergent.

Then rinse and dry without using abrasives or chemical solvents. **(pict.8)**



Do not wash the appliance by spraying high-pressure water on the machine. **(pict.9)**

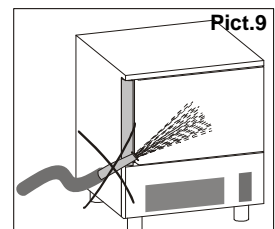

Do not rinse with sharp or abrasive tools, especially the evaporator. **(pict.10)**

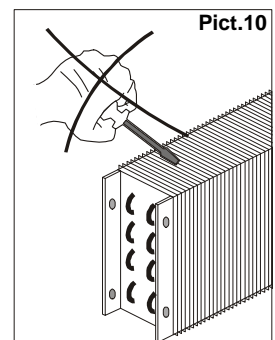

You may clean inside the evaporator after loosening the knobs and rotating the protection component. **(pict.11)**

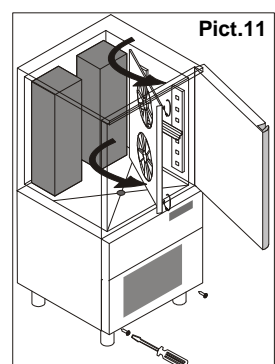

Remove the front control board with a tool and clean the raceway to remove all dirt. **(pict.12)**

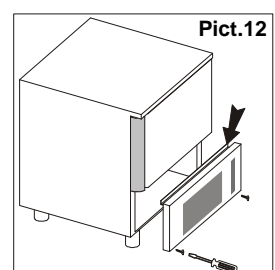

- INSTRUCTION MANUAL -

Wash the door gasket with water. Accurately dry with a dry cloth. We recommend wearing protecting gloves throughout the operations. (pict.13)

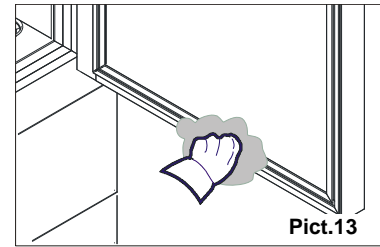

Pict.13

Hand-wash the probe using lukewarm water and a mild detergent or products with biodegradability higher than 90%. Rinse with water and sanitary solution. Do not use detergents containing solvents (such as trichloroethylene, etc) or abrasive powders

ATTENTION: do not use hot water to wash the probe (pict.14)

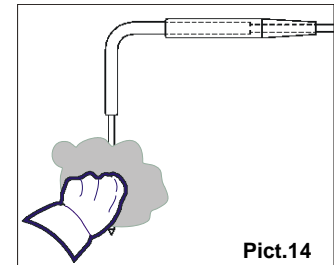

Pict.14

CLEANING THE AIR CONDENSER

The air condenser should be kept clean to ensure the appliance's performance and efficiency, as air should freely circulate inside the appliance. (pict.15)

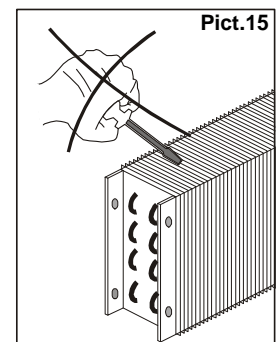

Pict.15

The condenser should therefore be cleaned every 30 days, using non-metal brushes to remove all dust and dirt from condenser blades.



Access to the condenser is obtained by removing the front panel. (pict.16)

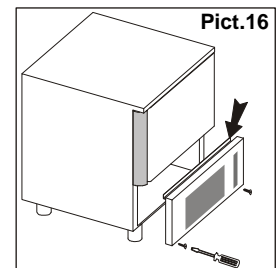

Pict.16

STAINLESS-STEEL MAINTENANCE

By stainless steel we mean INOX AISI 304 steel. We recommend following the instructions below for the maintenance and cleaning of stainless-steel parts. This is of the utmost importance to ensure the non-toxicity and complete hygiene of the processed foodstuffs. Stainless-steel is provided with a thin oxide layer which prevents it from rusting. However, some detergents may destroy or affect this layer, therefore causing corrosion. Before using any cleansing product, ask your dealer about a neutral chloriness cleansing product, as to avoid steel corrosions. If the surface has been scratched polish it with fine STAINLESS-STEEL wool or a synthetic-fibre abrasive sponge. Always rub in the direction of the silking. (pict.17)

WARNING: Never use iron wool for cleaning STAINLESS STEEL. Furthermore, avoid leaving iron wool on the appliance surface as tiny iron deposits may cause the surface to rust by contamination and affect the hygiene of the appliance.

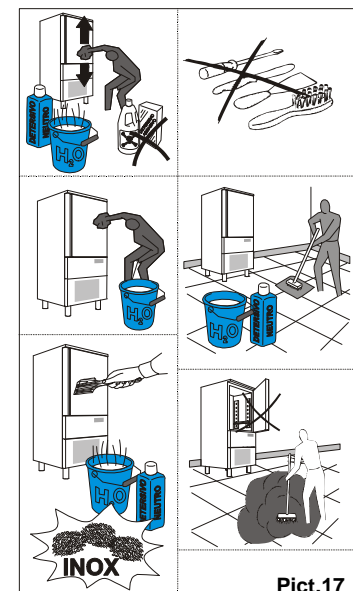

Pict.17

- INSTRUCTION MANUAL -

DISCONTINUED USE

Should the machine be disconnected over long periods, follow the instructions below to maintain the appliance in good condition:

Turn the mains switch OFF. (**pict.18**)

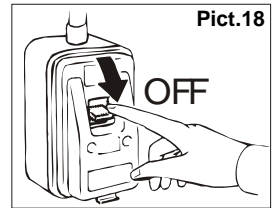

Disconnect the plug. (**pict.19**)

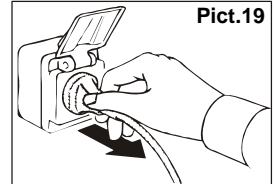

Empty the appliance and clean it in accordance with the instructions given in the chapter "CLEANING". Leave the door ajar to prevent a bad smell.

Cover the compressor unit with a nylon cloth to protect it from dust. (**pict.20**)

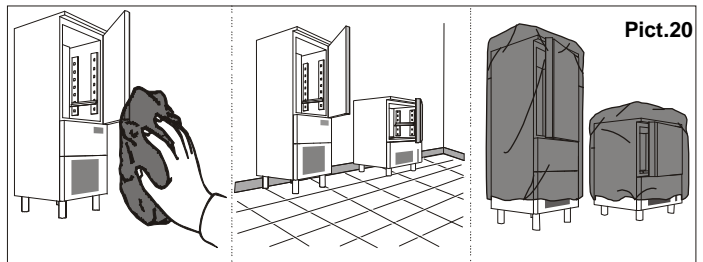

In case of appliances with remote control, if you decide to turn it off, remember to put the switch off also in the remote control.



- INSTALLATION MANUAL -

INSTALLATION

INTRODUCTION

After unpacking the appliance make sure it has not been damaged. **(pict.21)**
 Make sure the technical wiring specifications comply with the ratings (i.e., V, kW, Hz, no. phases and mains power). Check the power supply type, adjustments, performance and calibration of the device located before the appliance. Check and record the coolant type inside the system and refer to the recorded data in any refill.

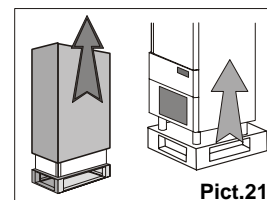

Pict.21

Please quote the product's serial number (shown on the rating plate) on any enquiry to the Manufacturer. **(pict.22)**

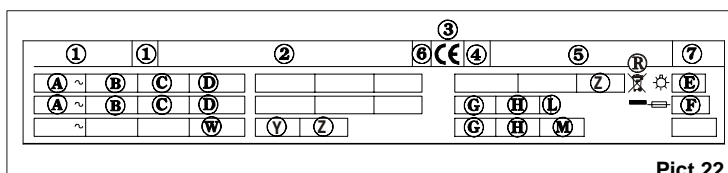

Pict.22

List of rates shown on the rating plate:

- | | |
|------------------------------------|----------------------------------|
| 1) Model | G) Coolant type |
| 2) Manufacturer's name and address | H) Coolant q.ty |
| 3) CE mark | L) Temperature grade |
| 4) Year of make | M) Max hydraulic supply pressure |
| 5) Serial number | N) Fan capacity |
| 6) Power insulation class | O) Mass cycle Kg |
| 7) Power protection class | P) Fan rotation speed |
| A) Input voltage | Q) Fan head |
| B) Electric current intensity | R) WEEE Symbol |
| C) Frequency | S) Water inlet temperature |
| D) Rated power | T) Water consumption |
| E) Total lamp power | W) Heating unit power |
| F) Fuse current | Z) Least pressure |



MAX ROOM TEMPERATURE (TAB.4)

Air-condenser units should not operate if room temperature is over 38°C. Above 32° C maximum output is not guaranteed.

The remote condensers must be installed outdoors out of direct sunlight or in suitable rooms. Always make sure that air ventilation is present. Check that suitable covers **(pict.23)** are used.

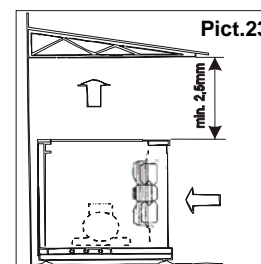

Pict.23

POSITIONING

The appliance must be installed and tested in full compliance with accident-prevention regulations contained in national law and current guidelines. Installers are to comply with any current local regulations.

- An omnipolar switch is to be installed before the appliance, in compliance with the current regulations applied in the country where the appliance is installed. **(pict.24)**

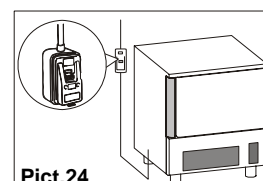

Pict.24

- INSTALLATION MANUAL -

- Do not place the refrigerated compartment near heat sources. (pict.25)

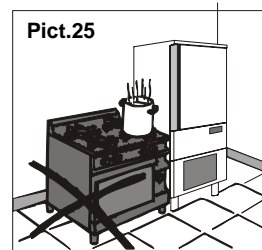

- Remove pvc protective film from all over the appliance. (pict.26)

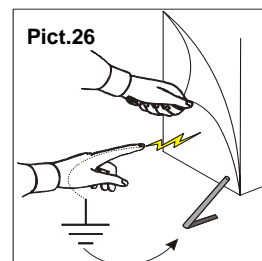

- Place the appliance onto the required working site. (pict.27)

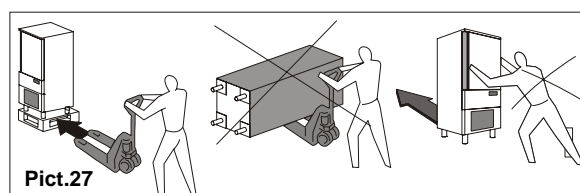

- Avoid locations with exposure to direct sunlight.
- Do not place the appliance in hot, poorly-ventilated rooms.



- Leave a min. 100-mm clearance around the appliance on the sides where air inlet and outlet are located. (pict.28)

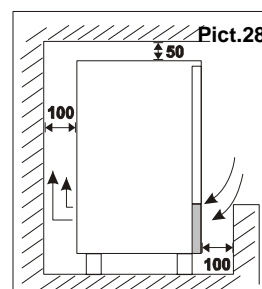

For models, depth 700, it is possible to bring the rear of the appliance closer to the wall.

- Level the appliance by means of adjustable feet. (pict.29)

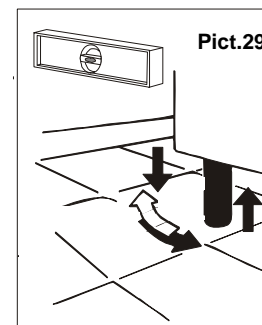

WARNING: If the appliance is not properly levelled the performance and condensate drain may be hampered.

- INSTALLATION MANUAL -

WIRING

The connection to power supply may be carried out at the back of the appliance after removing the protection grid. **(pict.31)**

IMPORTANT: 10kg models are equipped with a 2-mt single-phase cable without plug. 20kg models are equipped with a 2-mt three-phase supply cable without plug.

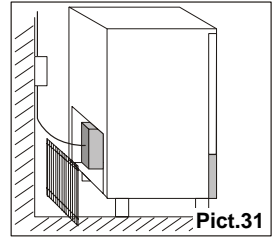

In models with distance condenser the cabinet and the unit **(pict.32)** must be connected separately.

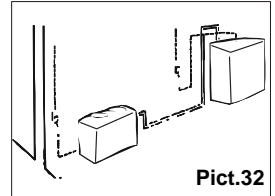

PLEASE USE CERTIFIED APPROVED MATERIALS

All wiring cables are to comply with the ratings shown on the technical specifications.

Cables are to be connected to the equipotential terminal. **(pict.34)**

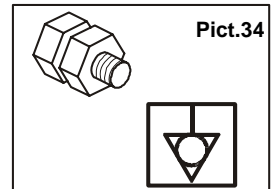

The grounding cable is to be directly connected to a good grounding system. **(pict.35)**

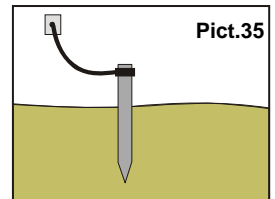

- INSTALLATION MANUAL -

GENERAL SETTING

TESTING

Carry out the following checkings:









- 1) Outside temperatures must be included between 10°C and 38°C.
- 2) Turn on the appliance and wait 30 minutes before the use if the external temperature is "low".
- 3) Check power input.
- 4) Carry out at least one full quick cooling cycle

Should the appliance have been transported horizontally instead of a vertical position DO NOT START THE APPLIANCE IMMEDIATELY. WAIT FOR AT LEAST 4 HOURS BEFORE OPERATING.

SERVICE FUNCTIONS

CHANGING PARAMETERS



	<p>With the card <i>Off</i>, press the <u>defrost</u> and <u>standby</u> keys for 3 seconds to gain access to the mode for programming parameters</p> <p>The <u>display</u> shows "PASS"</p>
	<p>Use the <u>up</u> and <u>down</u> keys to scroll all the user parameters</p>
	<p>Press the <u>core probe negative QC</u> key to gain access to service parameters</p> <p>The <u>display</u> shows the value "0"</p>
	<p>Use the <u>up</u> and <u>down</u> keys to select the password "-19"</p>
	<p>Press the <u>core probe negative QC</u> key to confirm the value</p> <p>If the value is correct, the <u>display</u> shows the first parameter</p>
	<p>Use the <u>up</u> and <u>down</u> keys to scroll all parameters</p>
	<p>Press the <u>core probe negative QC</u> key to confirm your selection</p>
	<p>Use the <u>up</u> and <u>down</u> keys to select the new parameter value</p>
	<p>Press the <u>core probe negative QC</u> key to confirm your selection</p>
	<p>Press the <u>standby</u> key to exit</p>

- INSTALLATION MANUAL -

DESCRIPTION OF PARAMETERS

Parameter	Description	min	MAX	Default	U.M.	LABEL
General Configuration						
P0	Scelta unità di misura per temperatura Temperature unit of measurement selection 0 = Fahrenheit 1 = Celsius	0	1	1	-	User
P1	Room probe offset	-10	10	0	°C	Service
P2	Core probe offset	-10	10	0	°C	Service
P3	Evaporator probe activation	0	1	0	-	Service
P4	Evaporator probe offset (valid if P3 = 1)	-10	10	0	°C	Service
P5	Condenser probe activation	0	1	0	°C	Service
P6	Condenser probe offset (if P5 = 1)	-10	10	0	°C	Service
P7	Buzzer sound duration at the end of QC 0 = no acoustic signal at the end of QC	0	99	10	sec	Service
P8	Time display mode 0 = minutes 1 = hours and minutes	0	1	0	-	Service
P9	Condenser temperature threshold for High Condens. Temperature Alarm	0	99	70	°C	Service
P10	High Condens. Temperature alarm output hysteresis	0	30	10	°C	Service
P11	K4 Output Control 0 = condenser fans 1 = door resistance	0	1	0	-	Service
Adjustment Setpoint						
Pr0	Adjustment hysteresis	+1	15	2	°C	Service
Pr1	Room setpoint in positive QC	-20	30	-3	°C	User
Pr2	Room setpoint in positive Storing	-20	30	+3	°C	User
Pr3	Room setpoint in negative QC	-50	20	-40	°C	User
Pr4	Room setpoint in negative Storing	-50	20	-25	°C	User
Pr5	Room setpoint for Hard phase	-50	20	-40	°C	User
Pr6	Product temperature end of positive QC	-20	30	+3	°C	User
Pr7	Product temperature end of negative QC	-30	20	-18	°C	User
Pr8	Product temperature end of Hard phase	-20	30	10	°C	User
Pr9	Product temperature setpoint at start of time count	-10	99	+65	°C	User
Pr10	Needle insertion test activation	0	1	1	-	Service
Pr11	Core and Room Temperature Delta in first phase of needle insertion test	0	99	5	°C	Service
Pr12	Duration second phase of Needle test	1	99	90	sec	Service
Pr13	Room temperature threshold for door resistance activation	-20	30	0	°C	Service
Pr14	Door resistance control hysteresis	1	10	2	°C	Service
Cycle timing						
Pt0	Max. duration time-controlled positive QC cycle	1	200	90	min	User
Pt1	Max. duration time-controlled negative QC cycle	1	400	240	min	User
Pt2	Hard phase duration (the value should be <= Pt0) 0= Hard cycle de-activated	0	200	0	min	User
Compressor Control						
PC0	Compressor start delay from power on	0	99	0	min	Service
PC1	Delay between two compressor ON	0	99	2	min	Service
PC2	Delay between compressor Off/On	0	99	2	min	Service
PC3	Compressor On/Off cycle with room probe alarm during Positive and Negative Storing	0	99	10	min	Service
PC4	Compressor ON time with room probe alarm during Positive Storing	0	99	3	min	Service



- INSTALLATION MANUAL -

Parameter	Description	min	MAX	Default	U.M.	LABEL
PC5	Compressor ON time with room probe alarm during Negative Storing	0	99	8	min	Service
Evaporator Fan Control						
PF0	Fan state with compressor off 0 = no relation between fans and compressor 1 = fans off with compressor off	0	1	0	-	Service
PF1	Room temperature threshold for fan stop	-50	99	70	°C	Service
PF2	Evaporator setpoint for fan control during QC (active if P3 = 1 only)	-50	99	-1	°C	Service
PF3	Hysteresis for ventilation control during QC (active if P3 = 1 only)	1	15	2	°C	Service
PF4	Fan state during defrost	0	1	0	-	Service
PF5	Fan stop duration after dripping	0	15	3	min/sec	Service
PF6	Condenser fan de-activation delay from compressor stop	0	300	0	Sec	Service
Defrost						
Pd0	Interval between defrost cycles 0 = automatic defrost de-activated	0	99	8	ore/min	Service
Pd1	Defrost type	0	2	2	-	Service
Pd2	Evaporator temperature threshold for end of defrost (active if P3 = 1 only)	-10	99	2	°C	Service
Pd3	Max. defrost duration	1	99	10	min/sec	Service
Pd4	Defrost activation at cycle start 0 = de-activated 1 = activated	0	1	0	-	Service
Pd5	Defrost activation delay from Storing start	0	99	40	min/sec	Service
Pd6	Dripping duration	0	99	2	min/sec	Service
Pd7	Control of compressor delays at defrost start 0 = delays ignored 1 = delays respected	0	1	1	-	Service
Pd8	Time unit selection 0 = hours and minutes 1 = minutes and seconds	0	1	0	-	Service
Pd9	Delay of defrost/compressor output activation	-400	400	0	sec	Service
Digital Inputs						
Pi0	Door input polarity 0 => contact open = door closed 1 => contact closed = door closed	0	1	0	-	Service
Pi1	Door open warning signal delay	0	400	60	sec	Service
Pi2	Door open alarm signal delay after warning signal warning	0	400	60	sec	Service
Pi3	Compressor stop delay from door opening	0	400	120	sec	Service
Pi4	Door opening effect on ventilation 0 = no effect 1 = ventilation stop	0	1	0	-	Service
Pi5	High Pressare Input polarity 0 => contact open = High Pressure not active 1 => contact closed = High Pressure not active	0	1	0	-	Service
Pi6	High Pressare Alarm delay	0	999	5	sec	Service
Serial Communication						
PL0	BaudRate 0 = 2400 1 = 4800 2 = 9600	0	2	2	-	Service
PL1	Parity 0 = no parity 1 = odd parity 2 = even parity	0	2	2	-	Service
PL2	Card address	1	247	1	-	Service



NOTE: If P0 is set to 0, all the min. and max. default parameters will be converted into degrees Fahrenheit.

- INSTALLATION MANUAL -

ALARMS AND FAULT ANALYSIS (TAB.5)

If the fault is not corrected by following the above instructions ask for skilled assistance and avoid carrying out any other operations, especially on the electricals. When informing the servicing company of the fault, state **1** and **5** numbers (pict.37)

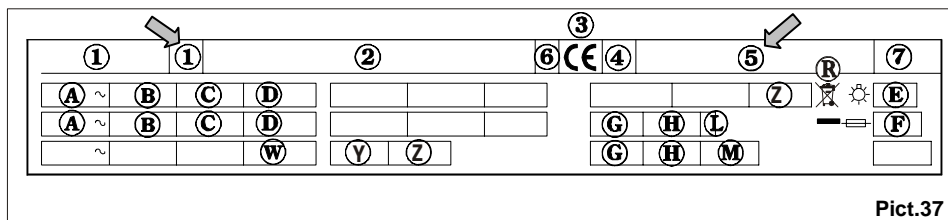

Pict.37

TAB.5

LABEL	FAULT/ PROBLEM	CAUSE	SOLUTION
Er1	On standby, QC cannot be started. During QC, the cycle stops and the card returns to standby. During storing, the cycle does not stop and the compressor starts cyclically.	Room Probe Faulty	Check connections and operation of the room probe
Er2	On standby, temperature-controlled QC cannot be started. During temperature-controlled QC, it switches to time-controlled cycle. No effect during storing	Product Probe Faulty	Check connections and operation of the product probe
Er3	On standby, during QC and Storing, no effect. Defrost, if any, stops through timeout.	Evaporator Probe Faulty (only if evaporator probe activated)	Check connection and operation of the evaporator probe
Er4	Just signal on display	Condenser Probe Faulty (only if condenser probe activated)	Check connection and operation of the condenser probe
AL1	On standby and during defrost, no effect	Door Open Alarm	Close the door
AL2	On standby, no effect. During QC and storing, the cycle stops and the card returns to standby.	High Pressure Alarm	Eliminate the alarm cause, switch off the card and then switch on again.
AL3	The running cycle stops, all outputs are de-activated, with the exception of condenser fans	Condens. High Temperature Alarm (only if condenser probe activated)	Wait for condenser temperature decrease
AL4		Needle not inserted	Check for proper insertion of the needle

Every alarm is signalled by the buzzer sound. The sound is a 5-sec beep repeated every 15 seconds. The alarm label blinks on the display.



- INSTALLATION MANUAL -

MAINTENANCE OF PANEL BOARD

The following operations are to be carried out by skilled staff only.

Turn the mains switch OFF. (**pict.38**)

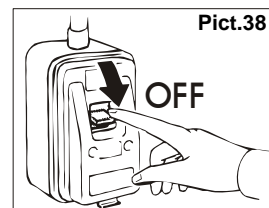

Disconnect the plug. (**pict.39**)

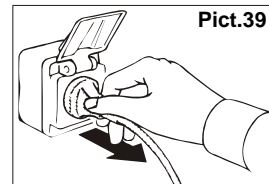

To be able to access the electric picture:

Mod. 10Kg

Remove the front panel (**pict.40**) with a tool and move the electric board box (**pict.41**) along the slides

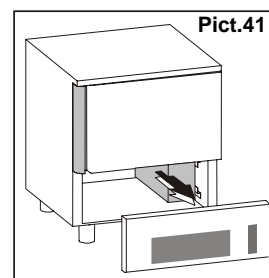
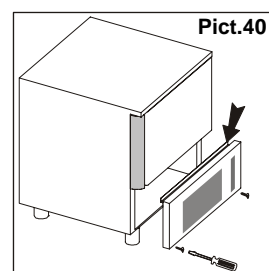

Remove the electrical board cover with a tool to access the internal components. Two delayed fuses are inserted in the power supply line. For replacement remove the cover by unscrewing the fixing screws, extract the blown fuse and replace it with a fuse having the same characteristics. (**pict.42**)

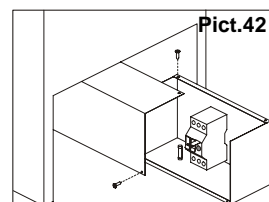

Mod. 20Kg-30Kg-40Kg

Remove the front panel (**pict.43**) and the control panel by means of a suitable tool.

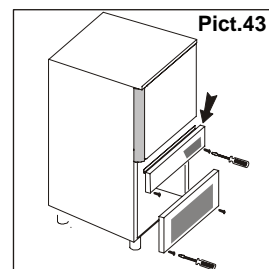

Remove the cover to have access to the components using a suitable tool (**pict.44**).

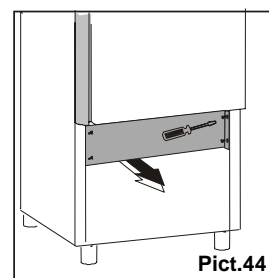

- INSTALLATION MANUAL -

Two delayed fuses are inserted in the power supply line; extract the blown fuse and replace it with a fuse having the same characteristics. (pict.45)

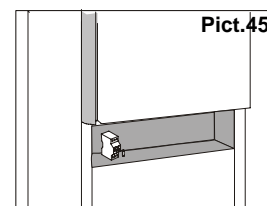

WIRING DIAGRAM PLATE

The diagram is shown on pict.47.

CONTROL AND SAFETY SYSTEMS

The following information concerns skilled staff only:

- **Door micro-switch:** Prevents the appliance from working when the door is open
- **Overall protection fuses:** Protect the whole power circuit from and short-circuits and overloads
- **Compressor thermal relay:** Operates in case of an overload or working failures
- **Motor-fan thermal relay:** Operates in case of an overload or working failures
- **Safety pressure-switch:** Operates in case of coolant over-pressure
- **Cabinet temperature control:** Is run by NTC probe through the relevant electronic card
- **Core temperature control:** Is run by PT100 probe through an electronic card
- **Controlled substances leakage:** appliances with a content of coolant exceeding 3 kg should be checked for leakage yearly

DISPOSAL



WASTE STORAGE

At the end of the product life, avoid release to the environment. The doors should be removed before disposal. Temporary storage of special waste is permitted while waiting for disposal by treatment and/or final collection. Dispose of special waste in accordance with the laws in force with regard to protection of the environment in the country of the user.

PROCEDURE FOR ROUGH DISMANTLING THE APPLIANCE

All countries have different legislation; provision laid down by the laws and the authorised bodies of the countries where the demolition takes place are therefore to be observed. A general rule is to deliver the appliance to specialised collection and demolition centres. Dismantle the refrigerator grouping together the components according to their chemical nature. The compressor contains lubricating oil and refrigerant, which may be recycled. The refrigerator components are considered special waste, which can be assimilated with domestic waste. Make the appliance totally unusable by removing the power cable and any door locking mechanisms in order to avoid the risk of anyone being trapped inside.

DISMANTLING OPERATIONS SHOULD BE CARRIED OUT BY QUALIFIED PERSONNEL.

THE SAFE DISPOSAL OF WASTE FROM ELECTRICAL AND ELECTRONIC EQUIPMENT (WEEE DIRECTIVE 2002/96/EC)

Do not dump pollutant material in the environment. Dispose of it in compliance with the relevant laws.

Under the WEEE (Waste Electrical and Electronic Equipment) Directive 2002/96/EC, when scrapping equipment the user must dispose of it at the specific authorised disposal centres, or reassign it, still installed, to the original seller on purchase of new equipment.

All equipment which must be disposed of in accordance with the WEEE Directive 2002/96/EC is marked with

a special symbol .

- INSTALLATION MANUAL -

The improper disposal of Waste Electrical and Electronic Equipment is liable to punishment under the relevant laws in the countries where the offence is committed.

Waste electrical and Electronic Equipment may contain hazardous substances with potential harmful effects on the environment and human health. You are urged to dispose of them properly.

REFRIGERANT MATERIAL SAFETY DATA SHEET

1) R404a: fluid components

- trifluoroethane (HFC 143a) 52%
- pentafluoroethane (HFC 125) 44%
- tetrafluoroethane (HFC 134a) 4%

GWP = 3750

ODP = 0

2) Hazard identification

Overexposure through inhalation may cause anaesthetic effects. Acute overexposure may cause cardiac rhythm disorders and sudden death. Product mists or sprays may cause ice burns of eyes and skin.

3) First aid procedures

• Inhalation:

keep injured person away from exposure, warm and relaxed. Use oxygen, if necessary. Give artificial respiration if respiration has stopped or is about to stop. In case of cardiac arrest give external cardiac massage. Seek immediate medical attention.

• Skin:

use water to remove ice from affected areas. Remove contaminated clothes.

CAUTION: clothes may adhere to skin in case of ice burns.

In case of contact with skin, wash with copious quantities of lukewarm water. In case of symptoms (irritation or blisters) seek medical attention.

• Eyes:

immediately wash with ocular solution or fresh water, keeping eyelids open for at least 10 minutes. Seek medical attention.

• Ingestion:

it can cause vomit.. If conscious, rinse mouth with water and drink 200-300 ml of water. Seek medical attention.

• Other medical treatment:

symptomatic treatment and support therapy when indicated. Do not administer adrenaline or sympatheticomimetic drugs after exposure, due to the risk of arrhythmia and possible cardiac arrest.

4) Environmental data

Persistence and degradation

• HFC 143a:

slow decomposition in lower atmosphere (troposphere). Duration in atmosphere is 55 years.

• HFC 125:

slow decomposition in lower atmosphere (troposphere). Duration in atmosphere is 40 years.

• HFC 134a:

relatively rapid decomposition in lower atmosphere (troposphere). Duration in atmosphere is 15.6 years.

• HFC 143a, 125, 134a:

does not affect photochemical smog (not included in volatile organic components – VOC – as established in the UNECE agreement). Does not cause ozone rarefaction.

Product exhausts released in the atmosphere do not cause long-term water contamination.



- INSTALLATION MANUAL -

DIMENSIONS

Please refer to the dimensions of your own appliance.

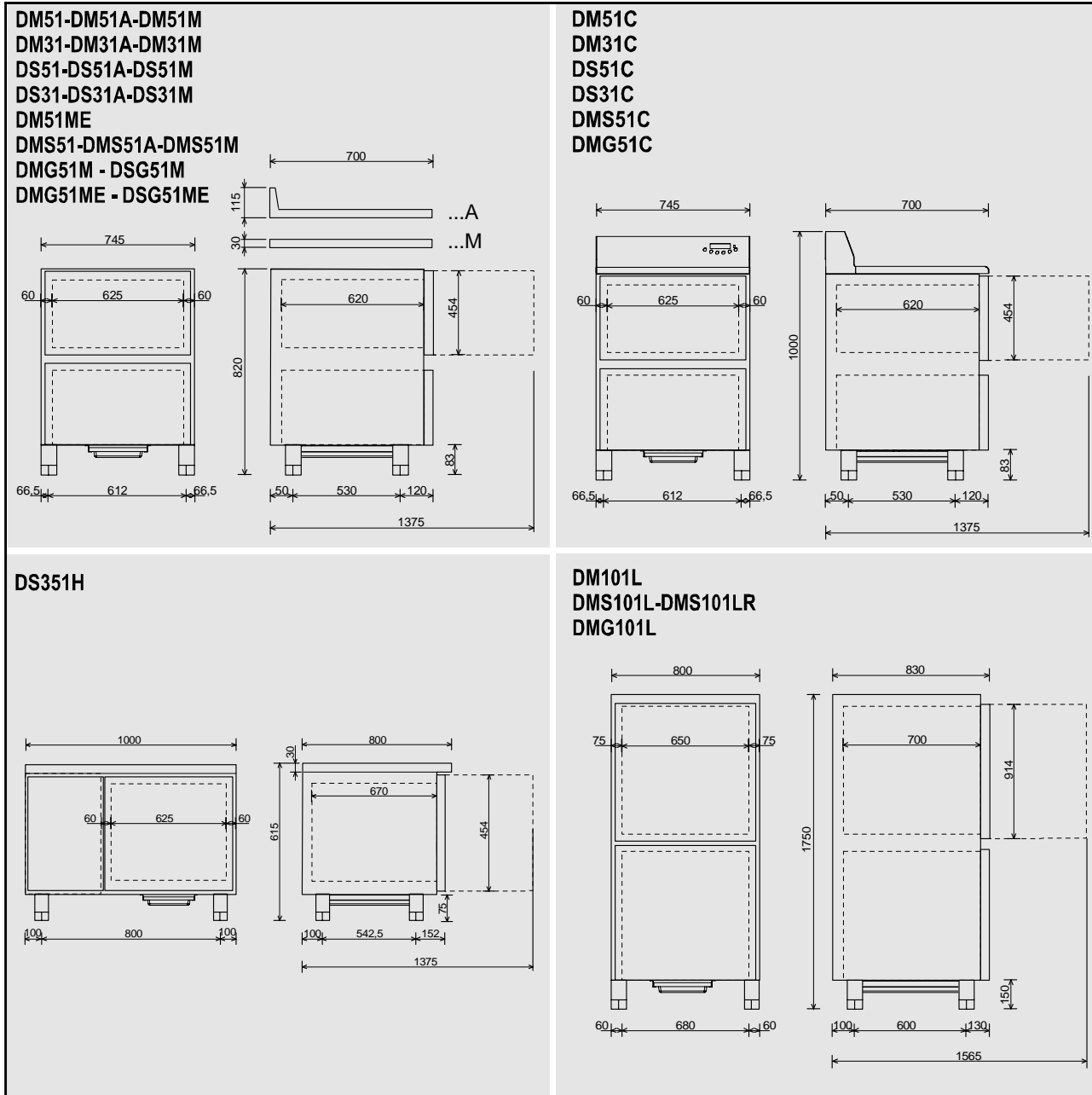

- INSTALLATION MANUAL -

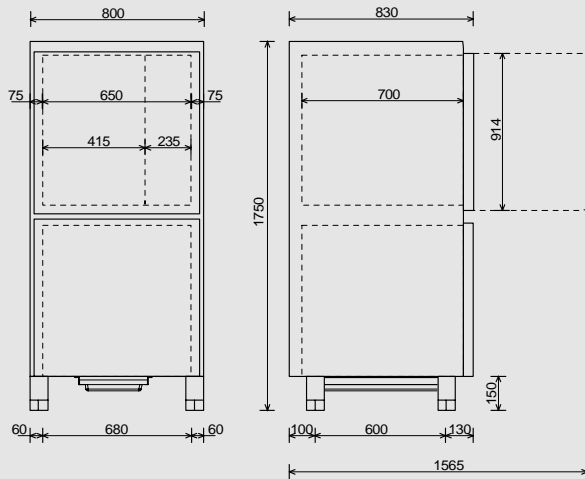

DMS101S-DMS101SR

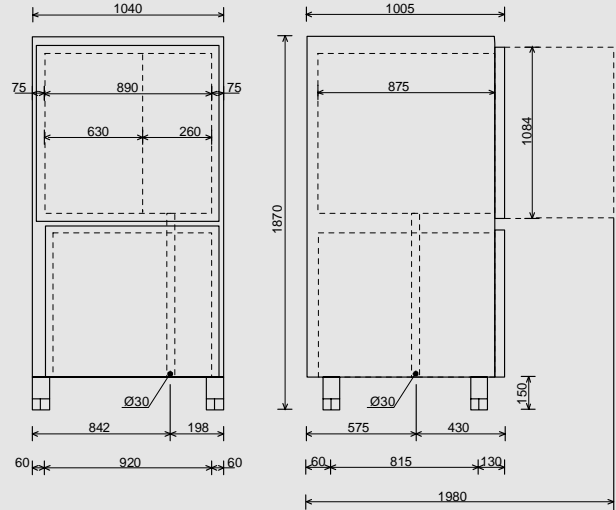

**DM72S
DMS72S-DMS72SR**

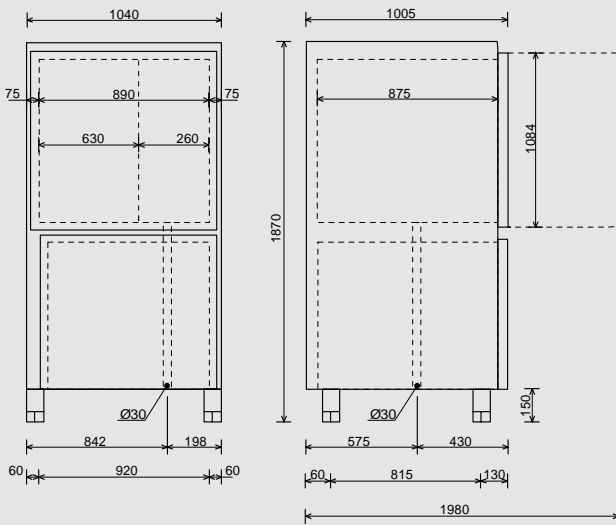

**DM102S
DMS102S-DMS102SR**

- INSTALLATION MANUAL -

ANNEXES

TAB.1

Model	DM31-DM31A DM31M-DM31C DS31-DS31A DS31M-DS31C (10Kg)	DS351H (10Kg)	DM51-DM51A DM51M-DM51C DS51-DS51A DS51M-DS51C (10Kg)	DM51ME (10Kg)	DM101L (20Kg L)	DM72S (30Kg)	DM102S (40Kg)
Gross weight	125	125	125	125	220	250	320
Net weight	115	115	115	115	195	220	290
Dimensions	745x700x820/850 /935/1000	1000x800 x615	745x700x820/850 /935/1000	745x700 x850	800x830 x1750	1040x1005 x1870	1040x1005 x1870
Capacity							
Mass /cycle [kg] (+90°C ÷ +3°C)	10,8	10,8	20	14,4	42	52	100
Mass /cycle [kg] (+90°C ÷ -18°C)	3,6	3,6	12	7,2	25	25	50
Internal volume [l]	90	90	90	90	195	480	480
Trays	5	5	5	5	10	10	10
	GN1/1 60x40	GN1/1 60x40	GN1/1 60x40	GN1/1 60x40	GN1/1 60x40	GN2/1 60x80	GN2/1 60x80
Power supply							
Voltage [V]	230 ~	230 ~	230 ~	230 ~	400 3N	400 3N	400 3N
Frequency [Hz]	50	50	50	50	50	50	50
Intensity [A]	3,5	3,5	6,2	4,5	6	6,5	10
Power input [W]	680	680	1350	800	3200	3600	5500
Refrigerating unit							
Refrigerating power [W]	283	283	617	368	2011	2011	2400
Evaporation temperature [°C]	-30	-30	-30	-30	-30	-30	-30
Cooling temperature [°C]	+90÷+3	+90÷+3	+90÷+3	+90÷+3	+90÷+3	+90÷+3	+90÷+3
Cooling time [min]	90	90	90	90	90	90	90
Freezing temperature [°C]	+90÷-18	+90÷-18	+90÷-18	+90÷-18	+90÷-18	+90÷-18	+90÷-18
Freezing time [min]	240	240	240	240	240	240	240
Condensation temperature [°C]	+54,5	+54,5	+54,5	+54,5	+54,5	+54,5	+54,5
Max room temperature [°C]	+32	+32	+32	+32	+32	+32	+32
Compressor type	Ermetic	Ermetic	Ermetic	Ermetic	Ermetic	Ermetic	Ermetic
Coolant	R404a	R404a	R404a	R404a	R404a	R404a	R404a
Coolant qty [g]	450	450	1400	700	2000	2300	3500
Condensation air	Air	Air	Air	Air	Air	Air	Air
Noise [dB] (A)	65	65	65	65	72	72	72

Model	DMS51-DMS51A DMS51M-DMS51C (10Kg)	DMS101L DMS101S (20Kg)	DMS72S (30Kg)	DMS102S (40Kg)	DMG51M DSG51M DMG51C (10Kg)	DMG51ME DSG51ME (10Kg)	DMG101L (20Kg)
Gross weight	125	220	250	320	125	125	220
Net weight	115	195	220	290	115	115	195
Dimensions	745x700x820/850 /935/1000	800x830x1750	1040x1005 x1870	1040x1005 x1870	745x700x850 /1000	745x700x850	800x830x1750
Capacity							
Mass /cycle [kg] (+90°C ÷ +3°C)	20	42	52	100	-	-	-
Mass /cycle [kg] (+90°C ÷ -18°C)	12	25	25	50	-	-	-
Mass /cycle [kg] (-10°C ÷ -25°C)	-	-	-	-	12	7	25
Internal volume [l]	90	195	480	480	90	90	195
Trays	5	10	10	10	6	2	4
	60x40 h=4	60x40 h=4	60x40 h=4	60x40 h=4	GN1/3 36x16,5 h=12	GN1/3 36x16,5 h=12	GN1/3 36x16,5 h=12
Power supply							
Voltage [V]	230 ~	400 3N	400 3N	400 3N	230 ~	230 ~	400 3N
Frequency [Hz]	50	50	50	50	50	50	50
Intensity [A]	6,2	6	6,5	10	6,2	4,5	6
Power input [W]	1350	3200	3600	5500	1350	800	3200
Refrigerating unit							
Refrigerating power [W]	617	2011	2011	2400	617	368	2011
Evaporation temperature [°C]	-30	-30	-30	-30	-30	-30	-30
Cooling temperature [°C]	+90÷+3	+90÷+3	+90÷+3	+90÷+3	+90÷+3	+90÷+3	+90÷+3
Cooling time [min]	90	90	90	90	90	90	90
Freezing temperature [°C]	+90÷-18	+90÷-18	+90÷-18	+90÷-18	+90÷-18	+90÷-18	+90÷-18
Freezing time [min]	240	240	240	240	240	240	240
Condensation temperature [°C]	+54,5	+54,5	+54,5	+54,5	+54,5	+54,5	+54,5
Max room temperature [°C]	+32	+32	+32	+32	+32	+32	+32
Compressor type	Ermetic	Ermetic	Ermetic	Ermetic	Ermetic	Ermetic	Ermetic
Coolant	R404a	R404a	R404a	R404a	R404a	R404a	R404a
Coolant qty [g]	1400	2000	2300	3500	1400	700	2000
Condensation air	Air	Air	Air	Air	Air	Air	Air
Noise [dB] (A)	65	72	72	72	65	65	72

Cooling time increases by 20% if the machine is leaning against the wall.

- INSTALLATION MANUAL -

TAB.4

Min. air circulation

Model	Air q.ty [m ³ /h]
10 kg	1.100
20 kg	3.500
30 kg	4.300
40 kg	9.000

- INSTALLATION MANUAL -

Pict.47

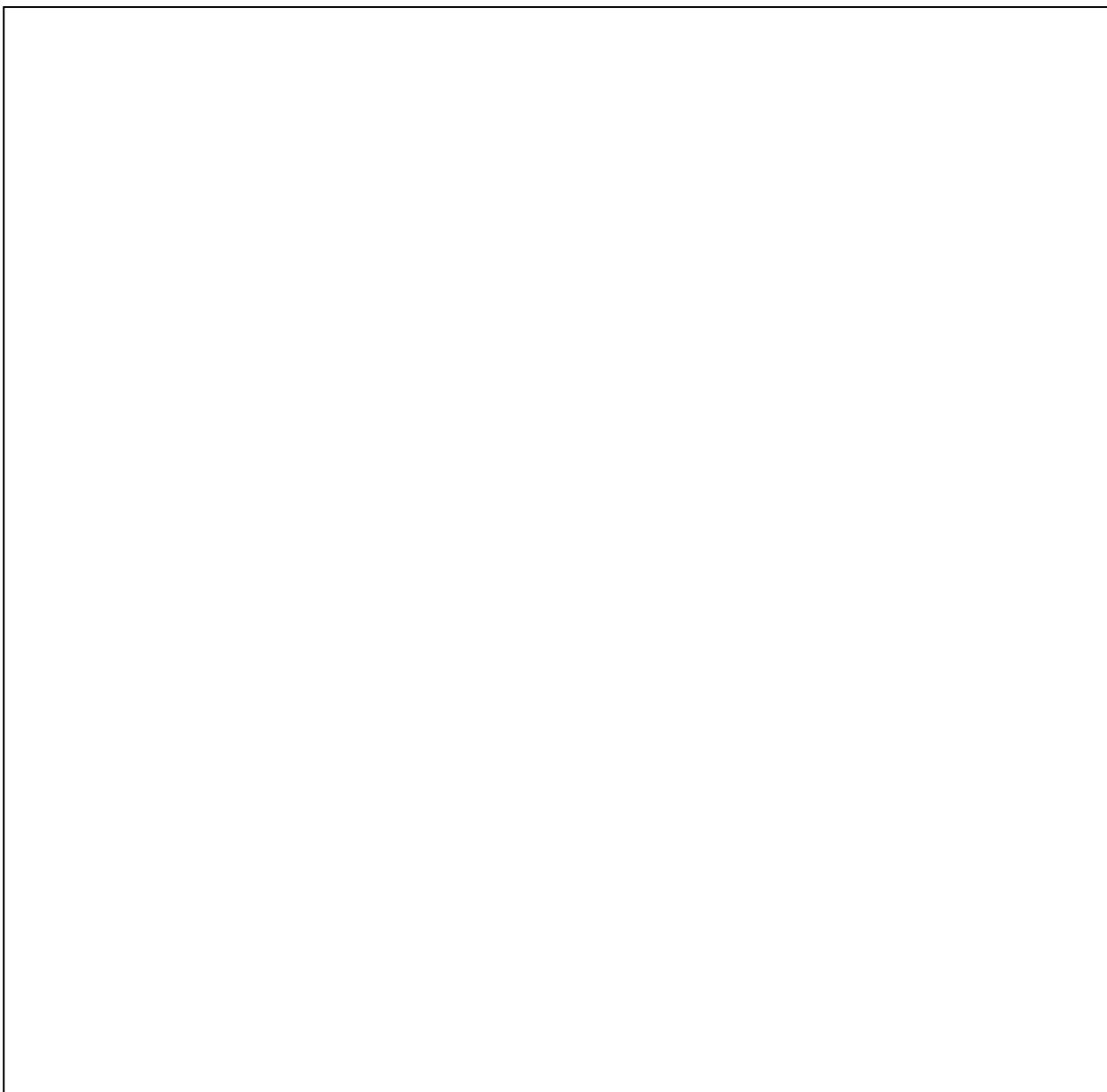

N°	DESCRIPTION	N°	DESCRIPTION
1	COMPRESSOR	69	GROUND TERMINAL
2	CONDENSER FAN	70	HIGH PRESSURE PRESSOSTAT
2A	THERMOSTATED CONDENSER FAN	70A	HIGH PRESSURE PRESSOSTAT
3	TERMINAL BOARD	73	FUSE-HOLDER WITH UNIPOLAR FUSE
3A	TERMINAL BOARD	75	ELECTROVALVE
9	1-SPEED EVAPORATOR FAN	76	MAGNETIC MICROSWITCH
9A	1-SPEED EVAPORATOR FAN	77	COMPARTMENT PROBE
9B	1-SPEED EVAPORATOR FAN	78	EVAP./DEFROST PROBE
12	DEFROST ELECTROVALVE	79	NEEDLE CORE PROBE
20	DOOR ANTICONDENSATE RESISTANCE	79A	MULTIPOINT NEEDLE CORE PROBE
20A	DOOR ANTICONDENSATE RESISTANCE	80	PTC RESISTANCE FOR COMPRESSOR CASING
21	DEFROST RESISTANCE	85A	BOX WITH TERMINAL BOARD (EVAP.)
21A	DEFROST RESISTANCE	85B	BOX WITH TERMINAL BOARD (COND.)
21B	DEFROST RESISTANCE	86	CONDENSER PROBE
21C	DEFROST RESISTANCE	97	LCD QUICK COOLER CARD
22	BOWL BOTTOM RESISTANCE	92	THERMAL PRINTER
65	CONTACTOR	94	DISCONNECTOR
66	THERMAL RELAY	97A	EVAP. FAN CHOKE MODULE.
67	EVAPORATOR FAN RUN CAPACITOR	97B	EVAP. FAN CHOKE MODULE
67A	EVAPORATOR FAN RUN CAPACITOR	112	LCD QUICK COOLER CARD
67B	EVAPORATOR FAN RUN CAPACITOR		