

**WING**  
**XW270L - XW271L**

**1. GENERAL WARNING**

**1.1 PLEASE READ BEFORE USING THIS MANUAL**

- This manual is part of the product and should be kept near the instrument for easy and quick reference.
- The instrument shall not be used for purposes different from those described hereunder. It cannot be used as a safety device.
- Check the application limits before proceeding.
- Dixell Srl reserves the right to change the composition of its products, even without notice, ensuring the same and unchanged functionality.

**1.2 SAFETY PRECAUTIONS**

- Check the supply voltage is correct before connecting the instrument.
- Do not expose to water or moisture: use the controller only within the operating limits avoiding sudden temperature changes with high atmospheric humidity to prevent formation of condensation
- Warning: disconnect all electrical connections before any kind of maintenance.
- Fit the probe where it is not accessible by the End User. The instrument must not be opened.
- In case of failure or faulty operation send the instrument back to the distributor or to "Dixell S.r.l." (see address) with a detailed description of the fault.
- Consider the maximum current which can be applied to each relay (see Technical Data).
- Ensure that the wires for probes, loads and the power supply are separated and far enough from each other, without crossing or intertwining.
- In case of applications in industrial environments, the use of mains filters (our mod. FT1) in parallel with inductive loads could be useful.

**2. GENERAL DESCRIPTION**

Models **XW270L** and **XW271L**, 38x185 mm format, are microprocessor based controllers suitable for applications on medium or low temperature refrigerating units. They are provided with six relay outputs to control compressor, defrost - which can be either electrical or hot gas - the evaporator fans, the lights, the alarm and an auxiliary output. In **XW271L** the auxiliary output is configured as anti-condensing heater. They are also provided with three NTC probe inputs, one for temperature control, one to control the defrost end temperature of the evaporator and the third, optional, for the display. There are two digital inputs (free contact) for the door switch and configurable by parameter. The standard TTL output allows the user to connect, by means of a TTL/RS485 external module, a ModBUS-RTU compatible monitoring system and to programme the parameter list with the "Hot Key". An optional output for remote display "XW-REP" is available.

**3. CONTROLLING LOADS**

**3.1 THE COMPRESSOR**

The regulation is performed according to the temperature measured by the thermostat probe with a positive differential from the set point: if the temperature increases and reaches set point plus differential the compressor is started and then turned off when the temperature reaches the set point value again. In case of fault in the thermostat probe the start and stop of the compressor are timed through parameters "CO<sub>n</sub>" and "CO<sub>F</sub>".

**3.2 FAST FREEZING**

When defrost is not in progress, it can be activated the keypad by holding the ▲ key pressed for about 3 seconds. The compressor operates in continuous mode for the time set through the "CCt" parameter. The cycle can be terminated before the end of the set time using the same activation key, ▲ for about 3 seconds.

**3.3 DEFROST**

Three defrost modes are available through the "tdF" parameter: defrost with electrical heater, hot gas or thermostatic defrost. The defrost interval is control by means of parameter "EdF": (EdF=in) the defrost is made every "ldF" time, (EdF=Sd) the interval "ldF" is calculate through Smart Defrost algorithm (only when the compressor is ON and the evaporator temperature is bigger than "SdF" parameter). At the end of defrost the drip time is controlled through the "FdF" parameter.

**3.4 CONTROL OF EVAPORATOR FANS**

The fan control mode is selected by means of the "FnC" parameter:  
**FnC=C-n** fans will switch ON and OFF with the compressor and **not run** during defrost;  
**FnC=C-y** fans will run continuously, but not during defrost  
 After defrost, there is a timed fan delay allowing for drip time, set by means of the "FnD" parameter.  
**FnC=O-n** fans will switch ON and OFF with the compressor and **run** during defrost;  
**FnC=O-y** fans will run continuously also during defrost









An additional parameter "FS<sub>t</sub>" provides the setting of temperature, detected by the evaporator probe, above which the fans are always OFF. This can be used to make sure circulation of air only if his temperature is lower than set in "FS<sub>t</sub>".

**3.5 AUXILIARY OUTPUT**



The auxiliary output is switch ON and OFF by means of the corresponding button on the keyboard. The auxiliary output of the **XW271L** model controls the anti-condensing heater and it is automatically activated if the room temperature is lower than the "SAA" parameter.

**4. KEYBOARD**







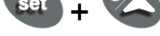





-  To display and modify target set point; in programming mode it selects a parameter or confirm an operation. By holding it pressed for 3s when max or min temperature is displayed it will be erased.
-  To see the max. stored temperature; in programming mode it browses the parameter codes or increases the displayed value. By holding it pressed for 3s the fast freezing cycle is started.
-  To see the min stored temperature; in programming mode it browses the parameter codes or decreases the displayed value.
-  By holding it pressed for 3s the defrost is started.
-  Switch ON and OFF the cold room light.
-  By holding it pressed for 3s Energy Saving function is started or stopped.
-  For XW270L model. Switch ON and OFF the auxiliary output.
-  For XW271L model. Switch ON and OFF the anti-condensing heater output.
-  Switch ON and OFF the instrument.

**KEY COMBINATIONS**

-  To lock and unlock the keyboard.
-  To enter the programming mode.
-  To exit the programming mode.

**4.1 USE OF LEDES**

Each LED function is described in the following table.

LED	MODE	Function
	ON	The compressor is running
	FLASHING	- Programming Phase (flashing with LED  ) - Anti-short cycle delay enabled
	ON	The fan is running
	FLASHING	Programming Phase (flashing with LED  )
	ON	The defrost is enabled
	FLASHING	Drip time in progress
	ON	The Fast Freezing cycle is enabled
	ON	- ALARM signal - In "Pr2" indicates that the parameter is also present in "Pr1"
	ON	(Present only in 'XW271L') The Anti-condensing heater relay (Aux) is ON.

Function of the LEDs placed on the left top side of buttons:

BUTTON	MODE	FUNCTION
SET	FLASHING	The Set point is displayed and it can be modified
SET	FAST FLASHING	The Energy Saving is enabled
DEFROST	ON	The Manual Defrost is activated
ENERGY SAVING	ON	The Energy Saving is enabled
LIGHT	ON	The Light is ON
AUX	ON	The Auxiliary output is ON (XW270L)
HEATER	ON	The Anti-condensing heater is ON (XW271L)
ON/OFF	ON	The instrument is OFF

**4.2 HOW TO SEE THE MIN TEMPERATURE**

1. Press and release the ▼ key.
2. The "Lo" message will be displayed followed by the minimum temperature recorded.
3. By pressing the ▼ key or waiting for 5s the normal display will be restored.

**4.3 HOW TO SEE THE MAX TEMPERATURE**

1. Press and release the ▲ key.
2. The "Hi" message will be displayed followed by the maximum temperature recorded.
3. By pressing the ▲ key or waiting for 5s the normal display will be restored.

**4.4 HOW TO RESET THE MAX AND MIN TEMPERATURE RECORDED**

To reset the stored temperature, when max or min temperature is displayed :  
 1. Press SET key until "rST" label starts blinking.

**N.B. After the installation RESET the temperature stored .**

**4.5 HOW TO SEE AND MODIFY THE SET POINT**

1. Push and immediately release the SET key: the display will show the Set point value;
2. The SET LED start blinking;
3. To change the Set value push the ▲ or ▼ arrows within 10s.
4. To memorise the new set point value push the SET key again or wait 10s.

## 4.6 TO START A MANUAL DEFOST



1. Push the DEF key for more than 2 seconds and a manual defrost will start.

## 4.7 TO ENTER IN PARAMETERS LIST "PR1"

To enter the parameter list "Pr1" (user accessible parameters) operate as follows:



1. Enter the Programming mode by pressing the Set and DOWN key for few seconds ( and start blinking).
2. The instrument will show the first parameter present in "Pr1"

## 4.8 TO ENTER IN PARAMETERS LIST "PR2"

To access parameters in "Pr2":

1. Enter the "Pr1" level.
2. Select "Pr2" parameter and press the "SET" key.
3. The "PAS" flashing message is displayed, shortly followed by "0 -" with a flashing zero.
4. Use  $\blacktriangle$  or  $\blacktriangledown$  to input the security code in the flashing digit; confirm the figure by pressing "SET". The security code is "321".
5. If the security code is correct the access to "Pr2" is enabled by pressing "SET" on the last digit.

Another possibility is the following: after switching ON the instrument the user can push Set and DOWN keys within 30 seconds.

**NOTE:** each parameter in "Pr2" can be removed or put into "Pr1" (user level) by pressing "SET" +  $\blacktriangledown$ . When a parameter is present in "Pr1" LED (i) is on.

## 4.9 HOW TO CHANGE THE PARAMETER VALUE

1. Enter the Programming mode.
2. Select the required parameter with  $\blacktriangle$  or  $\blacktriangledown$ .
3. Press the "SET" key to display its value ( and LED starts blinking).
4. Use  $\blacktriangle$  or  $\blacktriangledown$  to change its value.
5. Press "SET" to store the new value and move to the following parameter.

**To exit:** Press SET + UP or wait 15s without pressing a key.

**NOTE:** the new programming is stored even when the procedure is exited by waiting the time-out.

## 4.10 HOW TO LOCK THE KEYBOARD



1. Keep the  $\blacktriangle$  and  $\blacktriangledown$  keys pressed together for more than 3 s the  $\blacktriangle$  and  $\blacktriangledown$  keys.
2. The "POF" message will be displayed and the keyboard is locked. At this point it is only possible the viewing of the set point or the MAX o Min temperature stored and to switch ON and OFF the light, the auxiliary output and the instrument.

### TO UNLOCK THE KEYBOARD



Keep the  $\blacktriangle$  and  $\blacktriangledown$  keys pressed together for more than 3s.

## 4.11 ON/OFF FUNCTION



By pushing the ON/OFF key, the instrument shows "OFF" for 5 sec. and the ON/OFF LED is switched ON.

During the OFF status, all the relays are switched OFF and the regulations are stopped; if a monitoring system is connected, it does not record the instrument data and alarms.

**N.B. During the OFF status the Light and AUX buttons are active.**

## 4.12 TO SEE THE PROBE VALUES

1. Enter in "Pr2" level.
2. Select "Prd" parameter with  $\blacktriangle$  or  $\blacktriangledown$ .
3. Press the "SET" key to display "Pb1" label alternate with Pb1 value.
4. Use  $\blacktriangle$  and  $\blacktriangledown$  keys to display the other probe values.
5. Press "SET" to move to the following parameter.

## 5. PARAMETER LIST

### REGULATION

- Hy Differential:** (0,1+25,5°C; 1+45°F): Intervention differential for set point, always positive. Compressor Cut IN is Set Point Plus Differential (Hy). Compressor Cut OUT is when the temperature reaches the set point.
- LS Minimum set point limit:** (-50,0°C+SET; -58°F+SET) Sets the minimum acceptable value for the set point.
- US Maximum set point limit:** (SET+110°C; SET+230°F) Set the maximum acceptable value for set point.
- Ods Outputs activation delay at start up:** (0+255 min) This function is enabled at the initial start up of the instrument and inhibits any output activation for the period of time set in the parameter. (AUX and Light can work)
- AC Anti-short cycle delay:** (0+30 min) interval between the compressor stop and the following restart.
- CCt Thermostat override:** (0min +23h 50min) allows to set the length of the continuous cycle. Can be used, for instance, when the room is filled with new products.
- Con Compressor ON time with faulty probe:** (0+255 min) time during which the compressor is active in case of faulty thermostat probe. With CON=0 compressor is always OFF.
- COF Compressor OFF time with faulty probe:** (0+255 min) time during which the compressor is off in case of faulty thermostat probe. With COF=0 compressor is always active.

### DISPLAY

- CF Temperature measurement unit:** °C = Celsius; °F = Fahrenheit . When the measurement unit is changed the SET point and the values of the regulation parameters have to be modified
- rES Resolution (for °C):** (in = 1°C; de = 0,1°C) allows decimal point display.  
de = 0,1°C  
in = 1°C
- Lod Local display :** select which probe is displayed by the instrument:  
P1 = Thermostat probe  
P2 = Evaporator probe  
P3 = auxiliary probe  
1r2 = difference between P1 and P2 (P1-P2)

**Red Remote display :** select which probe is displayed by the remote display (XW-REP)

- P1 = Thermostat probe  
P2 = Evaporator probe  
P3 = auxiliary probe  
1r2 = difference between P1 and P2 (P1-P2)

### DEFOST

- tdF Defrost type:**  
rE = electrical heater (Compressor OFF)  
rT = thermostat defrost. During the defrost time "MdF", the heater switches On and OFF depending on the evaporator temperature and "dIE" value.  
in = hot gas (Compressor and defrost relays ON)
- EdF Defrost mode:**  
in = interval mode. The defrost starts when the time "ldf" is expired.  
sd = Smartfrost mode. The time ldf (interval between defrosts) is increased only when the compressor is running (even non consecutively) and only if the evaporator temperature is less than the value in "sdf" (set point for SMARTFROST).
- SdF Set point for SMARTFROST:** (-30+30 °C/ -22+86 °F) evaporator temperature which allows the ldf counting (interval between defrosts) in SMARTFROST mode.
- dTE Defrost termination temperature:** (-50,0+110,0°C; -58+230°F) (Enabled only when the evaporator probe is present) sets the temperature measured by the evaporator probe which causes the end of defrost.
- ldF Interval between defrosts:** (1+120h) Determines the time interval between the beginning of two defrost cycles.
- MdF (Maximum) duration of defrost:** (0+255 min) When P2P = n, no evaporator probe, it sets the defrost duration, when P2P = y, defrost end based on temperature, it sets the maximum length for defrost.
- dFd Display during defrost:**  
rt = real temperature;  
it = temperature reading at the defrost start;  
Set = set point;  
dEF = "dEF" label;  
dEG = "dEG" label;
- dAd Defrost display time out:** (0+255 min) Sets the maximum time between the end of defrost and the restarting of the real room temperature display.
- Fdt Drain down time:** (0+60 min.) time interval between reaching defrost termination temperature and the restoring of the control's normal operation. This time allows the evaporator to eliminate water drops that might have formed due to defrost.
- dPO First defrost after start-up:**  
y = Immediately;  
n = after the ldf time
- dAF Defrost delay after fast freezing:** (0min+23h 50min) after a Fast Freezing cycle, the first defrost will be delayed for this time.

### FANS

- FnC Fan operating mode:**  
C-n = running with the compressor, OFF during the defrost;  
C-y = running with the compressor, ON during the defrost;  
O-n = continuous mode, OFF during the defrost;  
O-y = continuous mode, ON during the defrost;
- Fnd Fan delay after defrost:** (0+255 min) The time interval between the defrost end and evaporator fans start.
- FSt Fan stop temperature:** (-50+110°C; -58+230°F) setting of temperature, detected by evaporator probe, above which the fan is always OFF.

### ALARMS

- ALC Temperature alarm configuration**  
rE = High and Low alarms related to Set Point  
Ab = High and low alarms related to the absolute temperature.
- ALU High temperature alarm setting:**  
ALC= rE , 0 + 50°C or 90°F  
ALC= Ab, ALL + 110°C or 230°F  
when this temperature is reached and after the ALD delay time the HA alarm is enabled.
- ALL Low temperature alarm setting:**  
ALC = rE , 0 + 50 °C or 90°F  
ALC = Ab , - 50°C or -58°F + ALU  
when this temperature is reached and after the ALD delay time, the LA alarm is enabled.
- AFH Temperature alarm and fan differential:** (0,1+25,5°C; 1+45°F) Intervention differential for temperature alarm set point and fan regulation set point, always positive.
- ALd Temperature alarm delay:** (0+255 min) time interval between the detection of an alarm condition and the corresponding alarm signalling.
- dAO Delay of temperature alarm at start-up:** (0min+23h 50min) time interval between the detection of the temperature alarm condition after the instrument power on and the alarm signalling.
- EdA Alarm delay at the end of defrost:** (0+255 min) Time interval between the detection of the temperature alarm condition at the end of defrost and the alarm signalling.
- dot Delay of temperature alarm after closing the door :** (0+255 min) Time delay to signal the temperature alarm condition after closing the door.
- doA Open door alarm delay:**(0+255 min) delay between the detection of the open door condition and its alarm signalling: the flashing message "dA" is displayed.
- tbA Buzzer and alarm relay silencing:** by pushing one of the keypad buttons.  
n= Only the Buzzer is silenced;  
y= Buzzer and relay are silenced.
- nPS Pressure switch number:** (0 +15) Number of activation of the pressure switch, during the "did" interval, before signalling the alarm event (12F = PAL).

### PROBE INPUTS

- Ot Thermostat probe calibration:** (-12,0+12,0°C/ -21+21°F) allows to adjust possible offset of the thermostat probe.
- OE Evaporator probe calibration:** (-12,0+12,0°C/ -21+21°F) allows to adjust possible offsets of the evaporator probe.
- O3 Auxiliary probe calibration:** (-12,0+12,0°C/ -21+21°F) allows to adjust possible offsets of the evaporator probe.
- P2P Evaporator probe presence:**  
n= not present: the defrost stops only by time; y= present: the defrost stops by temperature and time.
- P3P Auxiliary probe presence:** n= not present; y= present.
- HES Temperature increase during the Energy Saving cycle:** (-30,0°C + 30,0°C / -22+86°F) sets the increasing value of the set point during the Energy Saving cycle.

### DIGITAL INPUTS

- odc Compressor and fan status when open door:**  
no = normal;  
Fan = Fan OFF;  
CPr = Compressor OFF;

- F\_C = Compressor and fan OFF.
- I1P Door switch input polarity:**  
 CL : the digital input is activated by closing the contact;  
 OP : the digital input is activated by opening the contact.
- I2P Configurable digital input polarity:**  
 CL : the digital input is activated by closing the contact;  
 OP : the digital input is activated by opening the contact
- I2F Digital input operating mode:** configure the digital input function:  
 EAL = generic alarm;  
 bAL = serious alarm mode;  
 PAL = Pressure switch;  
 dFr = Start defrost;  
 AUS = Relay AUX actuation;  
 Es = Energy Saving;  
 onF = remote On/OFF.
- did Time interval/delay for digital input alarm:**(0÷255 min.) Time interval to calculate the number of the pressure switch activation when I2F=PAL. If I2F=EAL or bAL (external alarms), "did" parameter defines the time delay between the detection and the successive signalling of the alarm.
- SAA Set Point for anti-condensing heater:** (-50,0÷110,0°C; -58÷230°F) defines the room temperature setpoint to switch on the anti-condensing heater.

**OTHER**

- Adr RS485 serial address** (1÷247): Identifies the instrument address when connected to a ModBUS compatible monitoring system.
- Rel Release software:** (read only) Software version of the microprocessor.
- Ptb Parameter table:** (read only) it shows the original code of the Dixell parameter map.
- Prd Probes display:** (read only) display the temperature values of the evaporator probe Pb2 and the auxiliary probe Pb3.
- Pr2 Access to the protected parameter list** (read only).

**6. DIGITAL INPUTS**

The Wing series can support up to 2 free contact digital inputs. One is always configured as door switch, the second is programmable in seven different configurations by the "I2F" parameter.

**6.1 DOOR SWITCH INPUT**

It signals the door status and the corresponding relay output status through the "odc" parameter.  
 no = normal (any change);  
 Fan = Fan OFF;  
 CPR = Compressor OFF;  
 F\_C = Compressor and fan OFF.

Since the door is opened, after the delay time set through parameter "dOA", the alarm output is enabled and the display shows the message "dA". The alarm stops as soon as the external digital input is disabled again. During this time and then for the delay "dot" after closing the door, the high and low temperature alarms are disabled.

**6.2 CONFIGURABLE INPUT - GENERIC ALARM (EAL)**

As soon as the digital input is activated the unit will wait for "did" time delay before signalling the "EAL" alarm message. The outputs status don't change. The alarm stops just after the digital input is de-activated.

**6.3 CONFIGURABLE INPUT - SERIOUS ALARM MODE (BAL)**

When the digital input is activated, the unit will wait for "did" delay before signalling the "BAL" alarm message. The relay outputs are switched OFF. The alarm will stop as soon as the digital input is de-activated.

**6.4 CONFIGURABLE INPUT - PRESSURE SWITCH (PAL)**

If during the interval time set by "did" parameter, the pressure switch has reached the number of activation of the "nPS" parameter, the "PAL" pressure alarm message will be displayed. The compressor and the regulation are stopped. When the digital input is ON the compressor is always OFF.

**6.5 CONFIGURABLE INPUT - START DEFROST (DFR)**

It executes a defrost if there are the right conditions. After the defrost is finished, the normal regulation will restart only if the digital input is disabled otherwise the instrument will wait until the "Mdf" safety time is expired.

**6.6 CONFIGURABLE INPUT - RELAY AUX ACTUATION (AUS)**

This function allows to turn ON and OFF the auxiliary relay by using the digital input as external switch.

**6.7 CONFIGURABLE INPUT - ENERGY SAVING (ES)**

The Energy Saving function allows to change the set point value as the result of the SET+ HES (parameter) sum. This function is enabled until the digital input is activated.

**6.8 CONFIGURABLE INPUT - REMOTE ON/OFF (ONF)**

This function allows to switch ON and OFF the instrument.

**6.9 DIGITAL INPUTS POLARITY**

The digital inputs polarity depends on "I1P" and "I2P" parameters.  
 CL : the digital input is activated by closing the contact.  
 OP : the digital input is activated by opening the contact

**7. INSTALLATION AND MOUNTING**

Instruments XW270L, XW271L shall be mounted on vertical panel, in a 150x31 mm hole, and fixed using two screws Ø 3 x 2mm. To obtain an IP65 protection grade use the front panel rubber gasket (mod. RG-L). The temperature range allowed for correct operation is 0 - 60 °C. Avoid places subject to strong vibrations, corrosive gases, excessive dirt or humidity. The same recommendations apply to probes. Let the air circulate by the cooling holes.

**7.1 CUT OUT**

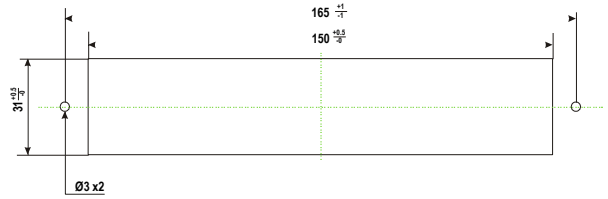

**7.2 XW270L/XW271L MOUNTING**

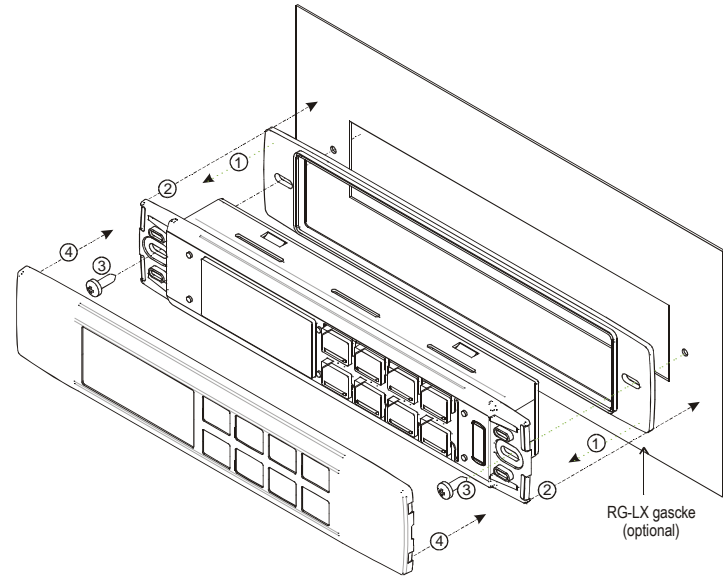

**8. ELECTRICAL CONNECTIONS**

The instruments are provided with screw terminal block to connect cables with a cross section up to 2,5 mm² for the digital and analogue inputs. Relays and power supply have a Faston connection (6,3mm). Heat-resistant cables have to be used. Before connecting cables make sure the power supply complies with the instrument's requirements. Separate the probe cables from the power supply cables, from the outputs and the power connections. Do not exceed the maximum current allowed on each relay, in case of heavier loads use a suitable external relay.  
**N.B.** Maximum current allowed for all the loads is 20A.

**8.1 PROBE CONNECTIONS**

The probes shall be mounted with the bulb upwards to prevent damages due to casual liquid infiltration. It is recommended to place the thermostat probe away from air streams to correctly measure the average room temperature. Place the defrost termination probe among the evaporator fins in the coldest place, where most ice is formed, far from heaters or from the warmest place during defrost, to prevent premature defrost termination.

**9. TTL SERIAL LINE**

The TTL connector allows, by means of the external module TTL/RS485, to connect the unit to a network line ModBUS-RTU compatible as the Dixell monitoring system XJ500 (Version 3.0). The same TTL connector is used to upload and download the parameter list of the "HOT KEY".

**10. USE OF THE PROGRAMMING "HOT KEY"**

The Wing units can UPLOAD or DOWNLOAD the parameter list from its own E2 internal memory to the "Hot Key" and vice-versa.

**10.1 DOWNLOAD (FROM THE "HOT KEY" TO THE INSTRUMENT)**

1. Turn OFF the instrument by means of the ON/OFF key, remove the TTL serial cable if present, insert the "Hot Key" and then turn the Wing ON.
2. Automatically the parameter list of the "Hot Key" is downloaded into the Wing memory, the "DoL" message is blinking. After 10 seconds the instrument will restart working with the new parameters.
3. Turn OFF the instrument remove the "Hot Key", plug in the TTL serial cable, then turn it ON again. At the end of the data transfer phase the instrument displays the following messages:  
 "end" for right programming. The instrument starts regularly with the new programming.  
 "err" for failed programming. In this case turn the unit off and then on if you want to restart the download again or remove the "Hot key" to abort the operation.

**10.2 UPLOAD (FROM THE INSTRUMENT TO THE "HOT KEY")**

1. Turn OFF the instrument by means of the ON/OFF key and remove the TTL serial cable if present; then turn it ON again.
2. When the Wing unit is ON, insert the "Hot key" and push ▲ key; the "uPL" message appears.
3. Push "SET" key to start the UPLoAD; the "uPL" message is blinking.
4. Turn OFF the instrument remove the "Hot Key", plug in the TTL serial cable, then turn it ON again. At the end of the data transfer phase the instrument displays the following messages:  
 "end" for right programming.  
 "err" for failed programming. In this case push "SET" key if you want to restart the programming again or remove the not programmed "Hot key".

11. ALARM SIGNALS

Message	Cause	Outputs
"P1"	Thermostat probe failure	Alarm output ON; Compressor output according to parameters "CO <sub>n</sub> " and "COF"
"P2"	Evaporator probe failure	Alarm output ON; Other outputs unchanged
"P3"	Auxiliary probe failure	Alarm output ON; Other outputs unchanged
"HA"	Maximum temperature alarm	Alarm output ON; Other outputs unchanged
"LA"	Minimum temperature alarm	Alarm output ON; Other outputs unchanged
"EE"	Data or memory failure	Alarm output ON; Other outputs unchanged
"dA"	Defrost timeout alarm	Alarm output ON; Other outputs unchanged
"dAL"	Door switch alarm	Alarm output ON; Other outputs unchanged
"EAL"	External alarm	Alarm output ON; Other outputs unchanged
"BAL"	Serious external alarm	Alarm output ON; Other outputs OFF
"PAL"	Pressure switch alarm	Alarm output ON; Other outputs OFF

The alarm message is displayed until the alarm condition is recovery.  
 All the alarm messages are showed alternating with the room temperature except for the "P1" which is flashing.  
 To reset the "EE" alarm and restart the normal functioning press any key, the "rSt" message is displayed for about 3s.

11.1 SILENCING BUZZER / ALARM RELAY OUTPUT

If "tbA = y", once the alarm signal is detected the buzzer and the relay are silenced by pressing any key.  
 If "tbA = n", only the buzzer is silenced while the alarm relay is on until the alarm condition recovers.

11.2 "EE" ALARM

The Dixell instruments are provided with an internal check for the data integrity. Alarm "EE" flashes when a failure in the memory data occurs. In such cases the alarm output is enabled.

11.3 ALARM RECOVERY

Probe alarms : "P1" (probe1 faulty), "P2" and "P3"; they automatically stop 10s after the probe restarts normal operation. Check connections before replacing the probe.  
 Temperature alarms "HA" and "LA" automatically stop as soon as the thermostat temperature returns to normal values or when the defrost starts.  
 Door switch alarm "dA" stop as soon as the door is closed.  
 External alarms "EAL", "BAL" stop as soon as the external digital input is disabled "PAL" alarm is recovered by switching OFF the instrument.

12. TECHNICAL DATA

**Housing:** self extinguishing ABS.  
**Case:** facia 38x185 mm; depth 76mm  
**Mounting:** panel mounting in a 150x31 mm panel cut-out with two screws. ∅ 3 x 2mm.  
 Distance between the holes 165mm  
**Protection:** IP20.  
**Frontal protection:** IP65 with frontal gasket mod RG-L. (optional)  
**Connections:** Screw terminal block ≤ 2,5 mm<sup>2</sup> heat-resistant wiring and 6,3mm Faston  
**Power supply:** 230Vac or. 110Vac ± 10%  
**Power absorption:** 7VA max.  
**Display:** 3 digits, red LED, 14,2 mm high.  
**Inputs:** 3 NTC probes  
**Digital inputs:** 2 free voltage  
**Relay outputs:** Total current on loads MAX. 20A  
**compressor:** relay SPST 20(8) A, 250Vac  
**light:** relay SPST 16(3) A, 250Vac  
**fans:** relay SPST 8(3) A, 250Vac  
**defrost:** relay SPST 8(3) A, 250Vac  
**alarm:** SPST relay 8(3) A, 250Vac  
**auxiliary:** SPST relay 16(3) A, 250Vac  
**Other output :** alarm buzzer  
**Serial output :** TTL standard  
**Communication protocol:** Modbus - RTU  
**Data storing:** on the non-volatile memory (EEPROM).  
**Kind of action:** 1B.  
**Pollution grade:** normal  
**Software class:** A.  
**Operating temperature:** 0+60 °C.  
**Storage temperature:** -25+60 °C.  
**Relative humidity:** 20+85% (no condensing)  
**Measuring and regulation range:** NTC probe: -40+110°C (-58+230°F)  
**Resolution:** 0,1 °C or 1 °C or 1 °F (selectable).  
**Accuracy (ambient temp. 25°C):** ±0,5 °C ±1 digit

13. CONNECTIONS

13.1 XW270L/XW271L

(\*) In XW271L, AUX is an anticondensing heater

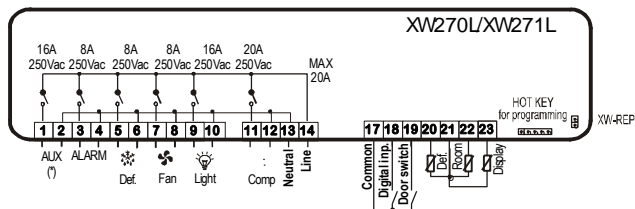

14. DEFAULT SETTING VALUES

Label	Name	Range	Default	Level
<b>REGULATION</b>				
Set	Set point	LS+US	-5	Pr1 Pr1
Hy	Differential	0,1+25,5 °C / 1+45°F	2	Pr1 Pr1
LS	Minimum set point	-50,0°C+SET / -58°F+SET	-30	Pr2 Pr2
US	Maximum set point	SET + 110°C / SET + 230°F	20	Pr2 Pr2
OdS	Outputs activation delay at start up	0+255 min.	1	Pr2 Pr2
AC	Anti-short cycle delay	0+30 min.	1	Pr1 Pr1
CcT	Compressor ON time during fast freezing	0 + 23h 50 min.	0	Pr2 Pr2
CO <sub>n</sub>	Compressor ON time with faulty probe	0+255 min.	15	Pr2 Pr2
COF	Compressor OFF time with faulty probe	0+255 min.	30	Pr2 Pr2
<b>DISPLAY</b>				
CF	Temperature measurement unit	°C + °F	°C	Pr2 Pr2
rES	Resolution (integer/decimal point)	in + de	de	Pr1 Pr1
Lod	Local display	P1 + r12	P1	Pr2 Pr2
Red	Remote display	P1 + r12	P1	Pr2 Pr2
<b>DEFROST</b>				
tdF	Defrost type	rE, rT, in	rE	Pr1 Pr1
EdF	Defrost mode	In, Sd	In	Pr2 Pr2
SdF	Set point for SMART DEFROST	-30 + +30°C / -22+86°F	0	Pr2 Pr2
dtE	Defrost termination temperature (1°Evaporator)	-50,0+110°C/ -58+230°F	8	Pr1 Pr1
IdF	Interval between defrost cycles	1+120h	6	Pr1 Pr1
MdF	(Maximum) length for 1° defrost	0+255 min.	30	Pr1 Pr1
dFd	Displaying during defrost	rt, it, SEt, dEF, dEG	it	Pr2 Pr2
dAd	MAX display delay after defrost	0+255 min.	30	Pr2 Pr2
Fdt	Draining time	0+60 min.	0	Pr2 Pr2
dPO	First defrost after start up	n + y	n	Pr2 Pr2
dAF	Defrost delay after fast freezing	0 + 23h 50 min.	2	Pr2 Pr2
<b>FANS</b>				
FnC	Fans operating mode	C-n, C-y, O-n, O-y	O-n	Pr2 Pr2
Fnd	Fans delay after defrost	0+255 min.	10	Pr2 Pr2
FSt	Fans stop temperature	-50,0+110°C/ -58+230°F	2	Pr2 Pr2
<b>ALARMS</b>				
ALC	Temperature alarms configuration	rE+Ab	rE	Pr2 Pr2
ALU	MAXIMUM temperature alarm	-50,0+110°C / -58+230°F	10	Pr1 Pr1
ALL	minimum temperature alarm	-50,0+110°C / -58+230°F	10	Pr1 Pr1
AFH	Temperature alarm and fan differential	0,1+25,5 °C / 1+45°F	2	
ALd	Temperature alarm delay	0+255 min.	15	Pr2 Pr2
dAO	Delay of temperature alarm at start up	0 + 23h 50 min.	1,3	Pr2 Pr2
EdA	Alarm delay at the end of defrost	0+255 min.	30	Pr2 Pr2
dot	Delay of temperature alarm after closing the door	0+255 min.	15	Pr2 Pr2
dOA	Open door alarm delay	0+255 min.	15	Pr2 Pr2
tBA	Alarm relay silencing	y + n	y	Pr2 Pr2
nPS	Pressure switch activation number	0+15	0	Pr2 Pr2
<b>ANALOGUE INPUTS</b>				
Ot	Thermostat probe calibration	-12,0+12,0°C / -21+21°F	0	Pr1 Pr1
OE	Evaporator probe calibration	-12,0+12,0°C / -21+21°F	0	Pr2 Pr2
O3	Auxiliary probe calibration	-12,0+12,0°C / -21+21°F	0	Pr2 Pr2
P2P	Evaporator probe presence	n + y	y	Pr2 Pr2
P3P	Auxiliary probe presence	n + y	n	Pr2 Pr2
HES	Temperature increase during the Energy Saving cycle	-30+30°C / -22+86°F	0	Pr2 Pr2
<b>DIGITAL INPUTS</b>				
OdC	Open door control	no, Fan, CPr, F_C	Fan	Pr2 Pr2
I1P	Door switch polarity	CL+OP	CL	Pr2 Pr2
I2P	Configurable digital input polarity	CL+OP	CL	Pr2 Pr2
i2F	Digital input configuration	EAL, bAL, PAL, dFr, AUS, ES, OnF	EAL	Pr2 Pr2
dId	Digital input alarm delay	0+255 min.	5	Pr2 Pr2
SAA	Set point for anti-condensing heater	-50,0+110°C/ -58+230°F	-20,0	---
<b>OTHER</b>				
Adr	Serial address	0+247	1	Pr1 Pr1
rEL	Software release	---	1,0	Pr2 Pr2
Ptb	Map code	---	---	Pr2 Pr2
Prd	Probes display	Pb1+Pb3	---	Pr2 Pr2
Pr2	Access parameter list	---	---	Pr2 Pr2



**Dixell S.r.l.** - Z.I. Via dell'Industria, 27 - 32010 Pieve d'Alpago (BL) ITALY  
 Tel. +39.0437.9833 r.a. - Fax +39.0437.989313 - EmersonClimate.com/Dixell - dixell@emerson.com